

**P  
M  
O**



Maayng  
Pagluto

Republic of the Philippines  
PROVINCE OF DAVAO DEL SUR  
Office of the Governor

# PROCUREMENT MANAGEMENT OFFICE BIDS AND AWARDS COMMITTEE

Mobile Nos. 0905-229-0526/0908-332-2024 (Goods), 0948-768-5848 (Infra)  
Telefax: (082) 553-9579

Website: [www.davaodelsur.gov.ph/pgo-bac](http://www.davaodelsur.gov.ph/pgo-bac)

Email Add.: [bac.davaodelsur2@gmail.com](mailto:bac.davaodelsur2@gmail.com)/[sbacdavaodelsur@gmail.com](mailto:sbacdavaodelsur@gmail.com)



## BIDDING DOCUMENTS

### One Job Order for the **CONSTRUCTION OF COVERED SPACE WITH STAGE located at SAN ISIDRO ELEMENTARY SCHOOL, SAN ISIDRO, MAGSAYSAY, DAVAO DEL SUR**

all in accordance to plans, specifications and scope of work and the Green Procurement Policy as adopted by Executive Order No. 30 series of 2019

**IB No. C-061-23**

**Date of Opening of Bids:** June 6, 2023 at 09:00 A.M.

**Start Date for Issuance of Bidding Documents:** May 11, 2023

H

Sixth Edition  
July 2020

## **TABLE OF CONTENTS**

<b>SECTION I.</b>	<b>INVITATION TO BID</b>
<b>SECTION II.</b>	<b>INSTRUCTIONS TO BIDDERS</b>
<b>SECTION III.</b>	<b>BID DATA SHEET</b>
<b>SECTION IV.</b>	<b>GENERAL CONDITIONS OF CONTRACT</b>
<b>SECTION V.</b>	<b>SPECIAL CONDITIONS OF CONTRACT</b>
<b>SECTION VI.</b>	<b>SPECIFICATIONS</b>
<b>SECTION VII.</b>	<b>DRAWINGS</b>
<b>SECTION VIII.</b>	<b>BILL OF QUANTITIES</b>
<b>SECTION IX.</b>	<b>CHECKLIST OF TECHNICAL AND FINANCIAL DOCUMENTS</b>
<b>SECTION X.</b>	<b>OTHER DOCUMENTS</b>

**SECTION II.**

**INSTRUCTION TO BIDDERS**

## *Section II. Instructions to Bidders*

### **1. Scope of Bid**

The PROVINCIAL GOVERNMENT OF DAVAO DEL SUR invites Bids for the **CONSTRUCTION OF COVERED SPACE WITH STAGE located at SAN ISIDRO ELEMENTARY SCHOOL, SAN ISIDRO, MAGSAYSAY, DAVAO DEL SUR**, with Project Identification Number C-061-23.

The Procurement Project (referred to herein as “**CONSTRUCTION OF COVERED SPACE WITH STAGE located at SAN ISIDRO ELEMENTARY SCHOOL, SAN ISIDRO, MAGSAYSAY, DAVAO DEL SUR**”) is for the construction of Works, as described in Section VI (Specifications).

### **2. Funding Information**

- 2.1. The GOP through the source of funding as indicated below for **CY 2023** in the amount of **P1,300,000.00**.
- 2.2. The source of funding is **Special Education Fund**:

### **3. Bidding Requirements**

The Bidding for the Project shall be governed by all the provisions of RA No. 9184 and its 2016 revised IRR, including its Generic Procurement Manual and associated policies, rules and regulations as the primary source thereof, while the herein clauses shall serve as the secondary source thereof.

Any amendments made to the IRR and other GPPB issuances shall be applicable only to the ongoing posting, advertisement, or invitation to bid by the BAC through the issuance of a supplemental or bid bulletin.

The Bidder, by the act of submitting its Bid, shall be deemed to have inspected the site, determined the general characteristics of the contracted Works and the conditions for this Project, such as the location and the nature of the work; (b) climatic conditions; (c) transportation facilities; (c) nature and condition of the terrain, geological conditions at the site communication facilities, requirements, location and availability of construction aggregates and other materials, labor, water, electric power and access roads; and (d) other factors that may affect the cost, duration and execution or implementation of the contract, project, or work and examine all instructions, forms, terms, and project requirements in the Bidding Documents.

### **4. Corrupt, Fraudulent, Collusive, Coercive, and Obstructive Practices**

The Procuring Entity, as well as the Bidders and Contractors, shall observe the highest standard of ethics during the procurement and execution of the contract. They or through an agent shall not engage in corrupt, fraudulent, collusive, coercive, and obstructive practices defined under Annex “I” of the 2016 revised IRR of RA No. 9184 or other integrity violations in competing for the Project.

### **5. Eligible Bidders**

- 5.1. Only Bids of Bidders found to be legally, technically, and financially capable will be evaluated.

- 5.2. The Bidder must have an experience of having completed a Single Largest Completed Contract (SLCC) that is similar to this Project, equivalent to at least fifty percent (50%) of the ABC adjusted, if necessary, by the Bidder to current prices using the PSA's CPI, except under conditions provided for in Section 23.4.2.4 of the 2016 revised IRR of RA No. 9184.
- A contract is considered to be "similar" to the contract to be bid if it has the major categories of work stated in the **BDS**.
- 5.3. For Foreign-funded Procurement, the Procuring Entity and the foreign government/foreign or international financing institution may agree on another track record requirement, as specified in the Bidding Document prepared for this purpose.
- 5.4. The Bidders shall comply with the eligibility criteria under Section 23.4.2 of the 2016 IRR of RA No. 9184.

## **6. Origin of Associated Goods**

There is no restriction on the origin of Goods other than those prohibited by a decision of the UN Security Council taken under Chapter VII of the Charter of the UN.

## **7. Subcontracts**

- 7.1. Subcontracting is not allowed.

## **8. Pre-Bid Conference**

The Procuring Entity will hold a pre-bid conference for this Project on the **May 23, 2023, at 9:00 A.M., Ralota Hall, Gov. Douglas Ra. Cagas Cultural Sports and Business Complex, Barangay Matti, Digos City, Davao del Sur** as indicated in paragraph 6 of the IB.

## **9. Clarification and Amendment of Bidding Documents**

Prospective bidders may request for clarification on and/or interpretation of any part of the Bidding Documents. Such requests must be in writing and received by the Procuring Entity, either at its given address or through electronic mail indicated in the IB, at least ten (10) calendar days before the deadline set for the submission and receipt of Bids.

## **10. Documents Comprising the Bid: Eligibility and Technical Components**

- 10.1. The first envelope shall contain the eligibility and technical documents of the Bid as specified in **Section IX. Checklist of Technical and Financial Documents**.
- 10.2. If the eligibility requirements or statements, the bids, and all other documents for submission to the BAC are in foreign language other than English, it must be accompanied by a translation in English, which shall be authenticated by the appropriate Philippine foreign service establishment, post, or the equivalent office having jurisdiction over the foreign bidder's affairs in the Philippines. For Contracting Parties to the Apostille Convention, only the translated documents shall be authenticated through an apostille pursuant to GPPB Resolution No. 13-2019 dated 23 May 2019. The English translation shall govern, for purposes of interpretation of the bid.
- 10.3. A valid special PCAB License in case of Joint Ventures, and registration for the type and cost of the contract for this Project. Any additional type of Contractor license or permit shall be indicated in the **BDS**.
- 10.4. A List of Contractor's key personnel (e.g., Project Manager, Project Engineers, Materials Engineers, and Foremen) assigned to the contract to be bid, with their

complete qualification and experience data shall be provided. These key personnel must meet the required minimum years of experience set in the **BDS**.

10.5. A List of Contractor's major equipment units, which are owned, leased, and/or under purchase agreements, supported by proof of ownership, certification of availability of equipment from the equipment lessor/vendor for the duration of the project, as the case may be, must meet the minimum requirements for the contract set in the **BDS**.

## **11. Documents Comprising the Bid: Financial Component**

11.1.1. The second bid envelope shall contain the financial documents for the Bid as specified in **Section IX. Checklist of Technical and Financial Documents**.

11.2. Any bid exceeding the ABC indicated in paragraph 1 of the **IB** shall not be accepted.

11.3. For Foreign-funded procurement, a ceiling may be applied to bid prices provided the conditions are met under Section 31.2 of the 2016 revised IRR of RA No. 9184.

## **12. Alternative Bids**

Bidders shall submit offers that comply with the requirements of the Bidding Documents, including the basic technical design as indicated in the drawings and specifications. Unless there is a value engineering clause in the **BDS**, alternative Bids shall not be accepted.

## **13. Bid Prices**

All bid prices for the given scope of work in the Project as awarded shall be considered as fixed prices, and therefore not subject to price escalation during contract implementation, except under extraordinary circumstances as determined by the NEDA and approved by the GPPB pursuant to the revised Guidelines for Contract Price Escalation guidelines.

## **14. Bid and Payment Currencies**

14.1. Bid prices may be quoted in the local currency or tradeable currency accepted by the BSP at the discretion of the Bidder. However, for purposes of bid evaluation, Bids denominated in foreign currencies shall be converted to Philippine currency based on the exchange rate as published in the BSP reference rate bulletin on the day of the bid opening.

14.2. Payment of the contract price shall be made in: **Philippine Pesos**.

## **15. Bid Security**

15.1. The Bidder shall submit a Bid Securing Declaration or any form of Bid Security in the amount indicated in the **BDS**, which shall be not less than the percentage of the ABC in accordance with the schedule in the **BDS**.

15.2. The Bid and bid security shall be valid for **75 Calendar Days** upon opening of bids. Any bid not accompanied by an acceptable bid security shall be rejected by the Procuring Entity as non-responsive.

## **16. Sealing and Marking of Bids**

Each Bidder shall submit one copy of the first and second components of its Bid.

The Procuring Entity may request additional hard copies and/or electronic copies of the Bid. However, failure of the Bidders to comply with the said request shall not be a ground for disqualification.

If the Procuring Entity allows the submission of bids through online submission to the given website or any other electronic means, the Bidder shall submit an electronic copy of its Bid, which must be digitally signed. An electronic copy that cannot be opened or is corrupted shall be considered non-responsive and, thus, automatically disqualified.

#### **17. Deadline for Submission of Bids**

17.1 Bids must be delivered to the Ralota Hall, Gov. Douglas Ra. Cagas Cultural Sports and Business Complex, Barangay Matti, Digos City, Davao del Sur **on or before June 6, 2023 at 9:00 A.M.** Late bids shall not be accepted. All bids must be accompanied by a bid security in any of the acceptable forms and in the amount stated in ITB Clause 18.

#### **18. Opening and Preliminary Examination of Bids**

18.1. The BAC shall open the Bids in public at the time, on the date, and at the place specified in paragraph 9 of the **IB**. The Bidders' representatives who are present shall sign a register evidencing their attendance. In case videoconferencing, webcasting or other similar technologies will be used, attendance of participants shall likewise be recorded by the BAC Secretariat.

In case the Bids cannot be opened as scheduled due to justifiable reasons, the rescheduling requirements under Section 29 of the 2016 revised IRR of RA No. 9184 shall prevail.

18.2. The preliminary examination of Bids shall be governed by Section 30 of the 2016 revised IRR of RA No. 9184.

#### **19. Detailed Evaluation and Comparison of Bids**

19.1. The Procuring Entity's BAC shall immediately conduct a detailed evaluation of all Bids rated "*passed*" using non-discretionary pass/fail criteria. The BAC shall consider the conditions in the evaluation of Bids under Section 32.2 of 2016 revised IRR of RA No. 9184.

19.2. If the Project allows partial bids, all Bids and combinations of Bids as indicated in the **BDS** shall be received by the same deadline and opened and evaluated simultaneously so as to determine the Bid or combination of Bids offering the lowest calculated cost to the Procuring Entity. Bid Security as required by **ITB** Clause 15 shall be submitted for each contract (lot) separately.

19.3. In all cases, the NFCC computation pursuant to Section 23.4.2.6 of the 2016 revised IRR of RA No. 9184 must be sufficient for the total of the ABCs for all the lots participated in by the prospective Bidder.

#### **20. Post Qualification**

Within a non-extendible period of five (5) calendar days from receipt by the Bidder of the notice from the BAC that it submitted the Lowest Calculated Bid, the Bidder shall submit its latest income and business tax returns filed and paid through the BIR Electronic Filing and Payment System (eFPS), and other appropriate licenses and permits required by law and stated in the **BDS**.

#### **21. Signing of the Contract**

The documents required in Section 37.2 of the 2016 revised IRR of RA No. 9184 shall form part of the Contract. Additional Contract documents are indicated in the **BDS**.

**SECTION III.**

**BID DATA SHEET**



## *Bid Data Sheet*

(IB No.: C-061-23)

ITB Clause				
5.2	For this purpose, contracts similar to the Project refer to contracts which have the same major categories of work, which shall be:  <b>Buildings: Construction</b>  (based on DPWH DO 14 Series of 2017) <i>Subcontracting is not allowed.</i>			
7.1	<i>"No further instructions."</i>			
10.3	The key personnel must meet the required minimum years of experience set below: <table style="width: 100%; border: none;"> <tr> <td style="text-align: center;"><u>Key Personnel</u></td> <td style="text-align: center;"><u>General Experience</u></td> <td style="text-align: center;"><u>Relevant Experience</u></td> </tr> </table>	<u>Key Personnel</u>	<u>General Experience</u>	<u>Relevant Experience</u>
<u>Key Personnel</u>	<u>General Experience</u>	<u>Relevant Experience</u>		
10.4	<i>"No further instructions."</i>			
10.5	The minimum major equipment requirements are the following: <table style="width: 100%; border: none;"> <tr> <td style="text-align: center;"><u>Equipment</u></td> <td style="text-align: center;"><u>Capacity</u></td> <td style="text-align: center;"><u>Number of Units</u></td> </tr> </table>	<u>Equipment</u>	<u>Capacity</u>	<u>Number of Units</u>
<u>Equipment</u>	<u>Capacity</u>	<u>Number of Units</u>		
12	<i>"No further instructions."</i> None.			
15.1	The bid security shall be in the form of a Bid Securing Declaration or any of the following forms and amounts: a. The amount of <b>not less than P26,000.00</b> [two percent (2%) of ABC], if bid security is in cash, cashier's/manager's check, bank draft/guarantee or irrevocable letter of credit; b. The amount of <b>not less than P65,000.00</b> [five percent (5%) of ABC], if bid security is in Surety Bond.			
19.2	Partial bid is not allowed. The infrastructure project is packaged in a single lot and the lot shall not be divided into sub-lots for the purpose of bidding, evaluation, and contract award.  In all cases, the NFCC computation must be sufficient for the contract to be awarded to the Bidder. <i>Permits and Clearances as required by the End-User.</i>			
20	<i>Post-Qualification Requirements: Latest Income Tax Returns, Business Tax Returns for the last 6 months.</i>			
21	1. Presentation of the Bidding Documents a. <b>Envelope 1 (Eligibility/ Technical Documents)</b> One (1) ORIGINAL COPY, another copy for COPY 1, and another copy for COPY 2.			

**b. Envelope 2 (Financial Proposal)**

One (1) ORIGINAL COPY, another copy for COPY 1, and another copy for COPY 2.

Such documents shall be duly signed by the bidders or its duly authorized representative/s.

Eligibility/Technical and Financial Proposal must be book bound and properly tabbed at the right side. Any documents submitted not book bound shall be rejected outright. For the Financial Proposal not exceeding ten (10) pages maybe book bound or securely stapled.

All copies must be properly marked (ORIGINAL COPY, COPY 1 AND COPY 2)

**Envelope 1 and Envelope 2 must be properly sealed, and will be placed in one sealed mother envelope.**

2. Other documents/materials to comply with other non-discretionary criteria and requirements as stated in the Instruction to Bidders:

- **Construction Methods**
- **Construction schedule and S-Curve**
- **Pert-CPM**
- **Manpower Utilization Schedule**
- **Equipment Utilization Schedule**
- **Construction Safety & Health Program**
- **Affidavit of Site Inspection**
- **Duly Notarized Certification as to compliance to Labor Laws and Standard**

The DOLE approved Construction Safety and Health Program is required before entering into Contract.

**SECTION IV.**

**GENERAL CONDITIONS  
OF CONTRACT**

# *General Conditions of Contract*

## **1. Scope of Contract**

This Contract shall include all such items, although not specifically mentioned, that can be reasonably inferred as being required for its completion as if such items were expressly mentioned herein. All the provisions of RA No. 9184 and its 2016 revised IRR, including the Generic Procurement Manual, and associated issuances, constitute the primary source for the terms and conditions of the Contract, and thus, applicable in contract implementation. Herein clauses shall serve as the secondary source for the terms and conditions of the Contract.

This is without prejudice to Sections 74.1 and 74.2 of the 2016 revised IRR of RA No. 9184 allowing the GPPB to amend the IRR, which shall be applied to all procurement activities, the advertisement, posting, or invitation of which were issued after the effectivity of the said amendment.

## **2. Sectional Completion of Works**

If sectional completion is specified in the Special Conditions of Contract (SCC), references in the Conditions of Contract to the Works, the Completion Date, and the Intended Completion Date shall apply to any Section of the Works (other than references to the Completion Date and Intended Completion Date for the whole of the Works).

## **3. Possession of Site**

3.1 The Procuring Entity shall give possession of all or parts of the Site to the Contractor based on the schedule of delivery indicated in the SCC, which corresponds to the execution of the Works. If the Contractor suffers delay or incurs cost from failure on the part of the Procuring Entity to give possession in accordance with the terms of this clause, the Procuring Entity's Representative shall give the Contractor a Contract Time Extension and certify such sum as fair to cover the cost incurred, which sum shall be paid by Procuring Entity.

3.2 If possession of a portion is not given by the above date, the Procuring Entity will be deemed to have delayed the start of the relevant activities. The resulting adjustments in contract time to address such delay may be addressed through contract extension provided under Annex "E" of the 2016 revised IRR of RA No. 9184.

## **4. The Contractor's Obligations**

The Contractor shall employ the key personnel named in the Schedule of Key Personnel indicating their designation, in accordance with ITB Clause 10.3 and specified in the **BDS**, to carry out the supervision of the Works.

The Procuring Entity will approve any proposed replacement of key personnel only if their relevant qualifications and abilities are equal to or better than those of the personnel listed in the Schedule.

## **5. Performance Security**

5.1. Within ten (10) calendar days from receipt of the Notice of Award from the Procuring Entity but in no case later than the signing of the contract by both parties, the successful

Bidder shall furnish the performance security in any of the forms prescribed in Section 39 of the 2016 revised IRR.

5.2. The Contractor, by entering into the Contract with the Procuring Entity, acknowledges the right of the Procuring Entity to institute action pursuant to RA No. 3688 against any subcontractor be they an individual, firm, partnership, corporation, or association supplying the Contractor with labor, materials and/or equipment for the performance of this Contract.

## **6. Site Investigations**

The Contractor, in preparing the Bid, shall rely on any Site Investigation Reports referred to in the SCC supplemented by any information obtained by the Contractor.

## **7. Warranty**

7.1. In case the Contractor fails to undertake the repair works under Section 62.2.2 of the 2016 revised IRR, the Procuring Entity shall forfeit its performance security, subject its property(ies) to attachment or garnishment proceedings, and perpetually disqualify it from participating in any public bidding. All payables of the GOP in his favor shall be offset to recover the costs.

7.2. The warranty against Structural Defects/Failures, except that occasioned-on force majeure, shall cover the period from the date of issuance of the Certificate of Final Acceptance by the Procuring Entity. Specific duration of the warranty is found in the SCC.

## **8. Liability of the Contractor**

Subject to additional provisions, if any, set forth in the SCC, the Contractor's liability under this Contract shall be as provided by the laws of the Republic of the Philippines.

If the Contractor is a joint venture, all partners to the joint venture shall be jointly and severally liable to the Procuring Entity.

## **9. Termination for Other Causes**

Contract termination shall be initiated in case it is determined prima facie by the Procuring Entity that the Contractor has engaged, before, or during the implementation of the contract, in unlawful deeds and behaviors relative to contract acquisition and implementation, such as, but not limited to corrupt, fraudulent, collusive, coercive, and obstructive practices as stated in ITB Clause 4.

## **10. Dayworks**

Subject to the guidelines on Variation Order in Annex "E" of the 2016 revised IRR of RA No. 9184, and if applicable as indicated in the SCC, the Dayworks rates in the Contractor's Bid shall be used for small additional amounts of work only when the Procuring Entity's Representative has given written instructions in advance for additional work to be paid for in that way.

## **11. Program of Work**

11.1. The Contractor shall submit to the Procuring Entity's Representative for approval the said Program of Work showing the general methods, arrangements, order, and timing for all

the activities in the Works. The submissions of the Program of Work are indicated in the SCC.

11.2. The Contractor shall submit to the Procuring Entity's Representative for approval an updated Program of Work at intervals no longer than the period stated in the SCC. If the Contractor does not submit an updated Program of Work within this period, the Procuring Entity's Representative may withhold the amount stated in the SCC from the next payment certificate and continue to withhold this amount until the next payment after the date on which the overdue Program of Work has been submitted.

## **12. Instructions, Inspections and Audits**

The Contractor shall permit the GOP or the Procuring Entity to inspect the Contractor's accounts and records relating to the performance of the Contractor and to have them audited by auditors of the GOP or the Procuring Entity, as may be required.

## **13. Advance Payment**

The Procuring Entity shall, upon a written request of the Contractor which shall be submitted as a Contract document, make an advance payment to the Contractor in an amount not exceeding fifteen percent (15%) of the total contract price, to be made in lump sum, or at the most two installments according to a schedule specified in the SCC, subject to the requirements in Annex "E" of the 2016 revised IRR of RA No. 9184.

## **14. Progress Payments**

The Contractor may submit a request for payment for Work accomplished. Such requests for payment shall be verified and certified by the Procuring Entity's Representative/Project Engineer. Except as otherwise stipulated in the SCC, materials and equipment delivered on the site but not completely put in place shall not be included for payment.

## **15. Operating and Maintenance Manuals**

15.1. If required, the Contractor will provide "as built" Drawings and/or operating and maintenance manuals as specified in the SCC.

15.2. If the Contractor does not provide the Drawings and/or manuals by the dates stated above, or they do not receive the Procuring Entity's Representative's approval, the Procuring Entity's Representative may withhold the amount stated in the SCC from payments due to the Contractor.

**SECTION V.**

**SPECIAL CONDITIONS  
OF CONTRACT**

# Special Conditions of Contract

GCC Clause	
2	<i>The Intended Completion Date is 75 calendar days upon receipt of the Notice to Proceed.</i>
4.1	<i>The Procuring Entity shall give possession in full the parts of the Site to the Contractor upon receipt of the Notice to Proceed.</i>
6	The site investigation reports are: <b>Site Inspection Report</b>
7.2	<i>[In case of semi-permanent structures, such as buildings of types 1, 2, and 3 as classified under the National Building Code of the Philippines, concrete/asphalt roads, concrete river control, drainage, irrigation lined canals, river landing, deep wells, rock causeway, pedestrian overpass, and other similar semi-permanent structures:] Five (5) years.</i>
10	a. Dayworks are applicable at the rate shown in the Contractor's original Bid.
11.1	"No further instruction."
11.2	"No further instruction."
13	The amount of the advance payment shall not exceed <b>Fifteen Percent (15%) of the total contract price to be recouped every progress billing.</b>
14	Materials and equipment delivered on the site but not completely put in place shall not be included for payment.
15.1	"No further instructions." The date by which "as built" drawings are required is <b>15 days prior turn-over and acceptance.</b>
15.2	"No further instructions."



# **SECTION VI.**

# **SPECIFICATIONS**

[See attached file.]

Name of Project  
Location

: CONSTRUCTION OF COVERED SPACE WITH STAGE  
: SAN ISIDRO ELEMENTARY SCHOOL, SAN ISIDRO, MAGSAYSAY, DAVAO DEL SI

## SPECIFICATIONS

Item	Description	Unit	Quantity
B.3	Permits and Clearances	1.00	1.s.
B.5	Project Billboard/ Signboard	1.00	each
B.7	Occupational Safety and Health	1.00	1.s.
803 (1)a	Structure Excavation (Common Soil)	15.16	cu.m.
804(1)b	Embankment from borrow	49.77	cu.m.
804 (4)	Gravel Fill	20.22	cu.m.
900 (1)c	Structural Concrete, Class A, 3000 psi, 28 days	21.84	cu.m.
902 (1)a1	Reinforcing Steel (Deformed) Grade 40	1,191.31	kg.
903 (2)	Formworks and Falseworks	59.31	sq.m.
1046(2)a1	CHB Non Load Bearing (including Reinforcing Steel), 100 mm	106.08	sq.m.
1027 (1)	Cement Plaster Finish	126.35	sq.m.
1001 (9)	Storm Drainage & Downspout	1.00	L.S.
1003(1)b2	Ceiling, 4.5mm, Wood Frame, Marine Plywood	161.50	sq.m.
1003(17)	Carpentry and Joinery Works	1.00	Lump sum
1013(2)a1	Fabricated Metal Roofing Accessory, Gauge 26 (0.551mm), Ridge/Hip Ro	17.00	ln.m
1013(2)a2	Fabricated Metal Roofing Accessory, Gauge 26 (0.701mm), Flashing	20.68	ln.m
1013(2)b1	Fabricated Metal Roofing Accessory, Gauge 26 (0.701mm), Gutters	34.00	ln.m
1014(1)b2	Pre-painted Metal Sheets, above 0.427mm., Rib Type, Long Span	175.78	sq.m.
1047 (1)	Structural Steel	1.00	1.s.
1047(8)	Structural Steel, Roof Framing	1.00	1.s.
1032(1)a	Painting Works, Masonry/Concrete	126.35	sq.m.
1032(1)b	Painting Works, Wood	161.50	sq.m.
1100 (10)	Conduits, Boxes & Fittings (Conduit Works/Conduit Rough-In)	1.00	1.s.
1101(33)	Wires and Wiring Devices	1.00	1.s.
1102 (1)	Panelboard with Main & Branch Breakers	1.00	1.s.
1103 (1)	Lighting Fixtures	1.00	1.s.

### NOTE:

Specifications shall be in accordance with the DPWH Standard Specifications for Public Works Structures. Volume III 2019

Prepared by:

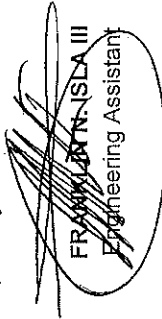
  
FRANCISCO S. III  
Engineering Assistant

Reviewed by:

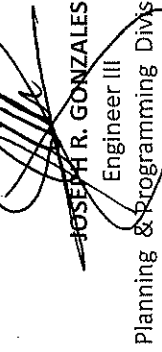
  
JOSEPH R. GONZALES  
Engineer III  
Planning & Programming Division Head

Approved by:

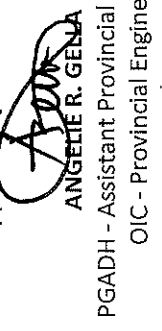
  
ANGELLE R. GENIA  
PGADH - Assistant Provincial Engineer  
OIC - Provincial Engineer  
As per Memo No. 22 - 2023

# **SECTION VII.**

## **DRAWINGS**

[The **Detailed Engineering Design** is available at the Provincial Government of Davao del Sur, Procurement Management Office, Office of the BAC Secretariat for Infrastructure Projects, Room 16, Executive Building of Provincial Capitol, Mati, Digos City, upon purchase of the corresponding bidding documents.]



REPUBLIC OF THE PHILIPPINES  
PROVINCE OF DAVAO DEL SUR  
**PROVINCIAL ENGINEER'S OFFICE**  
SAN AGUSTIN, DIGOS CITY, DAVAO DEL SUR

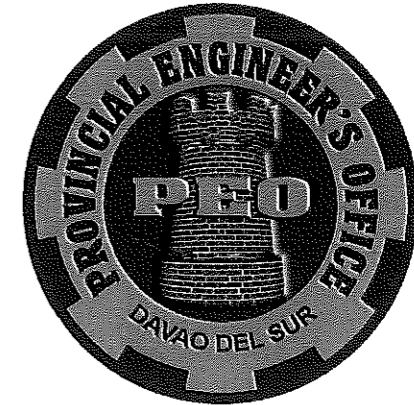

DETAILED ENGINEERING DESIGN FOR

**CONSTRUCTION OF COVERED SPACE WITH STAGE**

LOCATION: SAN ISIDRO ELEMENTARY SCHOOL, SAN ISIDRO,  
MAGSAYSAY, DAVAO DEL SUR

**PROJECT DESCRIPTION**

COVERED SPACE W/ STAGE = 16.00m X 9.00m = 144.00 sq.m.

TOTAL AREA = 144.00 sq.m.

SUBMITTED:

  
**JOSEPH R. GONZALES**  
ENGINEER III

PLANNING AND PROGRAMMING DIVISION HEAD

RECOMMENDING APPROVAL:

  
**ANGELIE R. GELLA**

PGADH - ASSISTANT PROVINCIAL ENGINEER  
OIC - PROVINCIAL ENGINEER  
(AS PER MEMO NO. 22-2023)

APPROVED:

  
**YVONNE RONA CAGAS**  
PROVINCIAL GOVERNOR

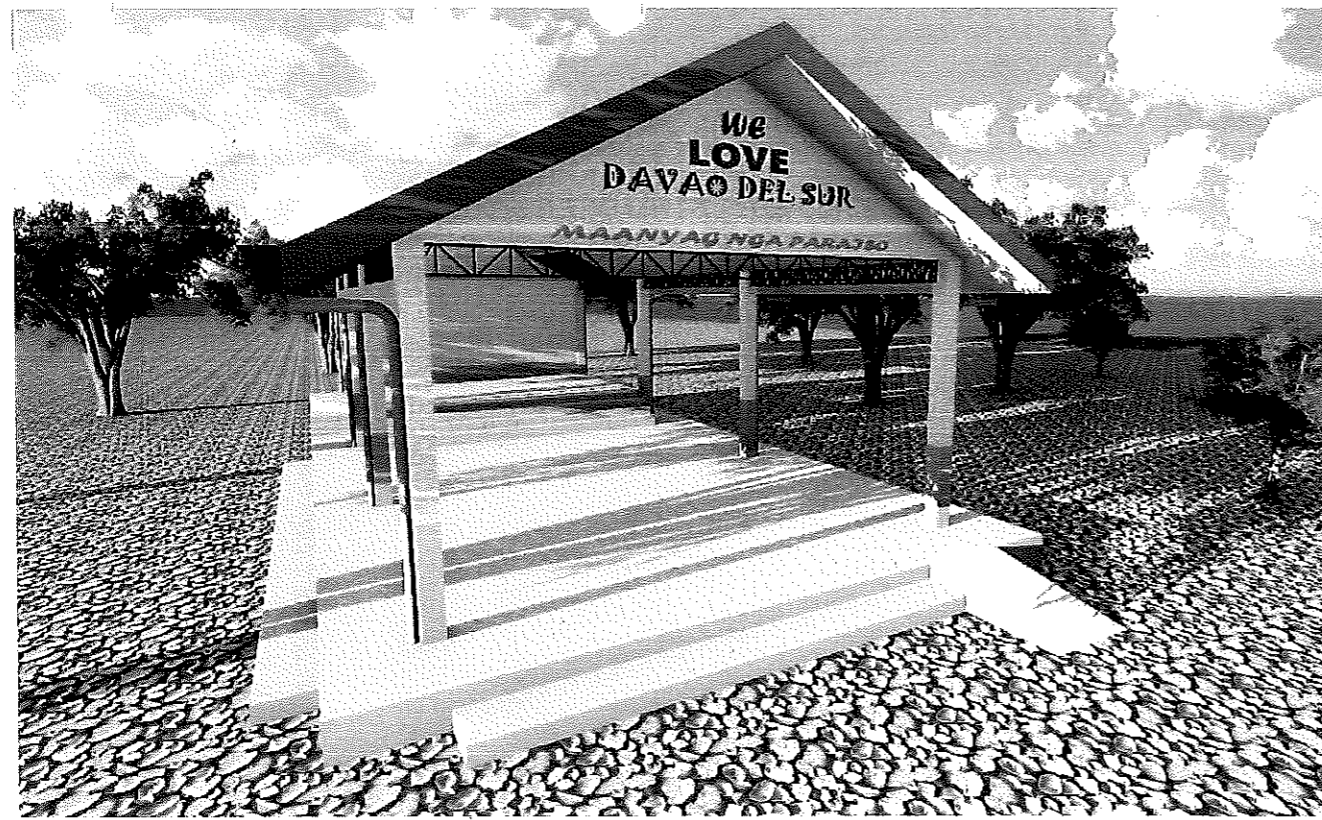

P E R S P E C T I V E

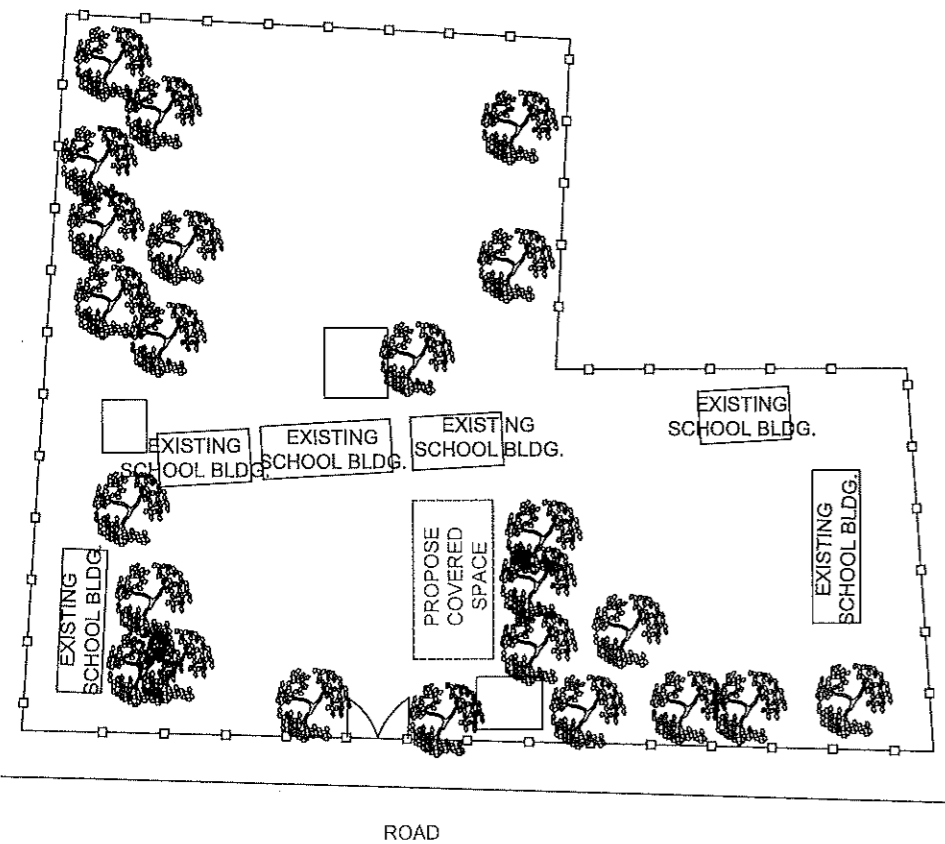

2 SITE DEVELOPMENT PLAN  
A-1 SCALE N T S



3 LOCATION PLAN  
A-1 SCALE N T S

TABLE OF CONTENTS

A-0	ARCHITECTURAL
A-1	- PERSPECTIVE - SITE DEVELOPMENT PLAN - LOCATION PLAN
A-2	- FLOOR PLAN - RIGHT ELEVATION - LEFT ELEVATION
A-3	- FRONT ELEVATION - REAR ELEVATION - CEILING SECTION DETAILS
A-4	- ROOF PLAN - REFLECTED CEILING PLAN
A-5	- ISOMETRIC VIEW OF STAIR @ STAIR - EAVES DETAIL - GUTTER DETAILS
S-0	STRUCTURAL
S-1 & S-2	- GENERALS NOTES
S-3	- FOUNDATION PLAN - C1F1 DETAILS - C2F1 DETAILS - SECTION THRU A-A DETAILS
S-4	- WF1 DETAILS - SECTION THRU B-B DETAILS - LINTEL BEAM DETAILS - WF3 DETAILS - RAMP DETAILS - FRONT STEPS DETAILS - SIDE STEPS DETAILS
S-5	- ROOF FRAMING DETAILS - RAFTER DETAILS - SPOT DETAILS - STEEL GIRT 1 DETAILS - STRUT DETAILS - STEEL GIRT 2 DETAILS
E-0	ELECTRICAL
E-1	ELECTRICAL PLAN
O-0	OTHERS
O-1	PROJECT BILLBOARD DETAILS
O-2	SUMMARY OF QUANTITIES

REPUBLIC OF THE PHILIPPINES  
DEPARTMENT OF WORKS AND HIGHWAYS

OFFICE OF THE BUILDING OFFICIAL

DISTRICT/CITY/MUNICIPALITY

LAND USE AND ZONING

LINE AND GRADE

ARCHITECTURAL

STRUCTURAL

SANITARY

ELECTRICAL

MECHANICAL



REPUBLIC OF THE PHILIPPINES  
PROVINCIAL ENGINEER'S OFFICE  
SAN AGUSTIN, DIGOS CITY, DAVAO DEL SUR

PROJECT TITLE:  
CONSTRUCTION OF COVERED SPACE WITH STAGE  
LOCATION: SAN ISIDRO ELEMENTARY SCHOOL, SAN ISIDRO, MAGSAYSAY, DAVAO DEL SUR

PREPARED BY:  
FRANKLIN N. ISLA, III  
ENGINEERING ASSISTANT

REVIEWED BY:  
JOSEPH R. GONZALES  
ENGINEER - III  
PLANNING AND PROGRAMMING DIV. HEAD

RECOMMENDING APPROVAL:  
ANGELIE R. GELLA  
PGADH - ASSISTANT PROVINCIAL ENGINEER  
OIC - PROVINCIAL ENGINEER  
(AS PER MEMO NO. 22 - 2023)

APPROVED BY:  
YVONNE ROSA CAGASI  
PROVINCIAL GOVERNOR

SHEET NO.:  
A-1  
1/13

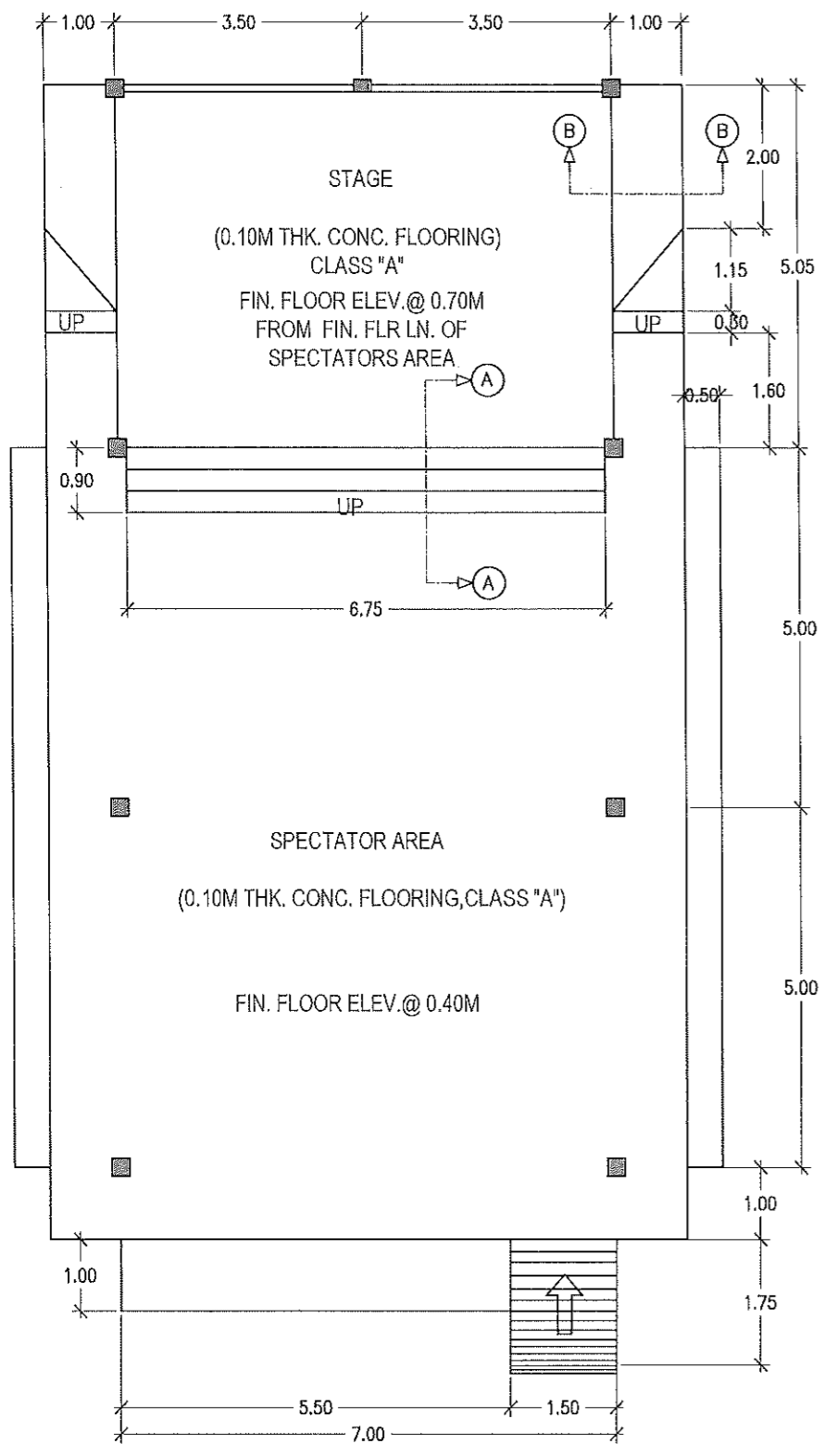

**1 FLOOR PLAN**  
A2 SCALE 1 : 100

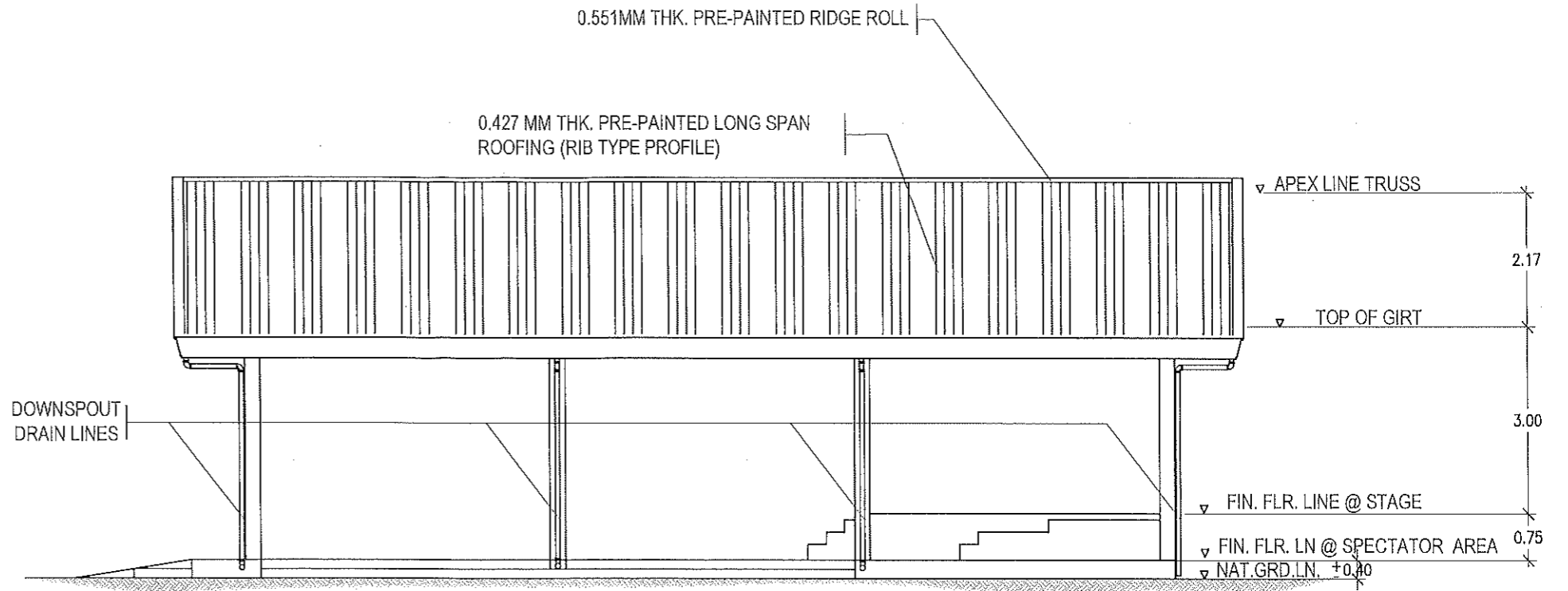

**2 RIGHT ELEVATION**  
A2 SCALE 1 : 100

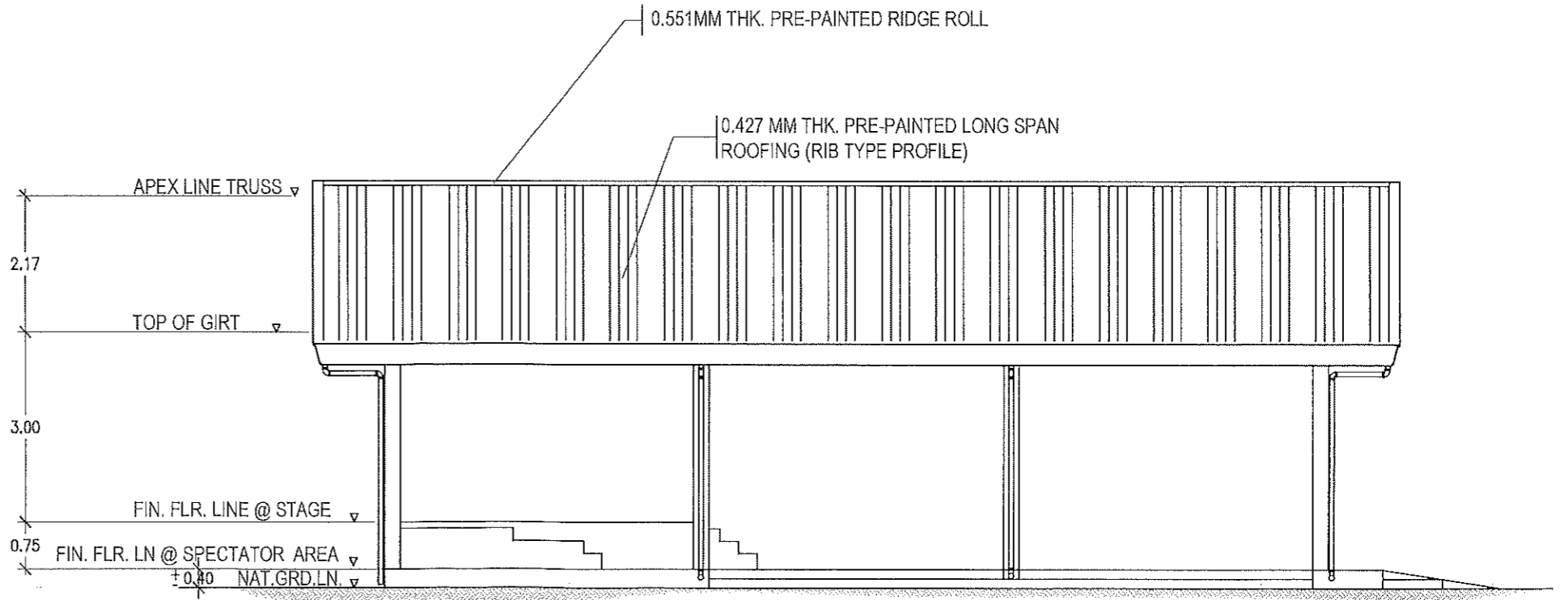

**3 LEFT ELEVATION**  
A2 SCALE 1 : 100



REPUBLIC OF THE PHILIPPINES  
**PROVINCIAL ENGINEER'S OFFICE**  
SAN AGUSTIN, DIGOS CITY, DAVAO DEL SUR

PROJECT TITLE: **CONSTRUCTION OF COVERED SPACE WITH STAGE**  
LOCATION: SAN ISIDRO ELEMENTARY SCHOOL, SAN ISIDRO, MAGSAYSAY, DAVAO DEL SUR

PREPARED BY:  
*Franklin N. Isla III*  
**FRANKLIN N. ISLA III**  
ENGINEERING ASSISTANT

REVIEWED BY:  
*Joseph R. Gonzales*  
**JOSEPH R. GONZALES**  
ENGINEER - III  
PLANNING AND PROGRAMMING DIV. HEAD

RECOMMENDING APPROVAL:  
*Angelie R. Gella*  
**ANGELIE R. GELLA**  
PGADH - ASSISTANT PROVINCIAL ENGINEER  
OIC - PROVINCIAL ENGINEER  
(AS PER MEMO NO. 22 - 2023)

APPROVED BY:  
*Yvonne Ron Cagas*  
**YVONNE RON CAGAS**  
PROVINCIAL GOVERNOR

SHEET NO.:  
**A-2**  
**2/13**

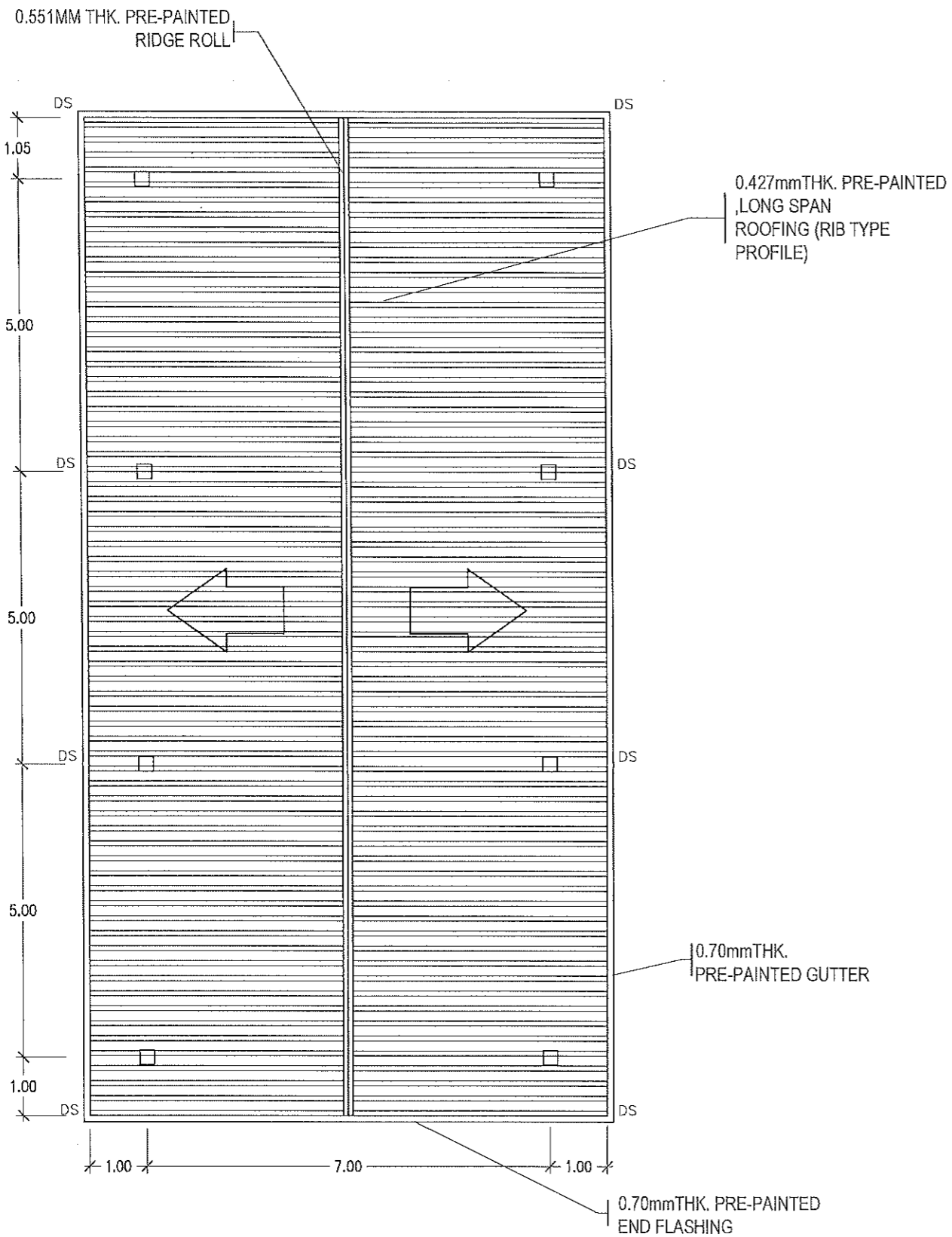

1 ROOF PLAN  
A4 SCALE 1: 100

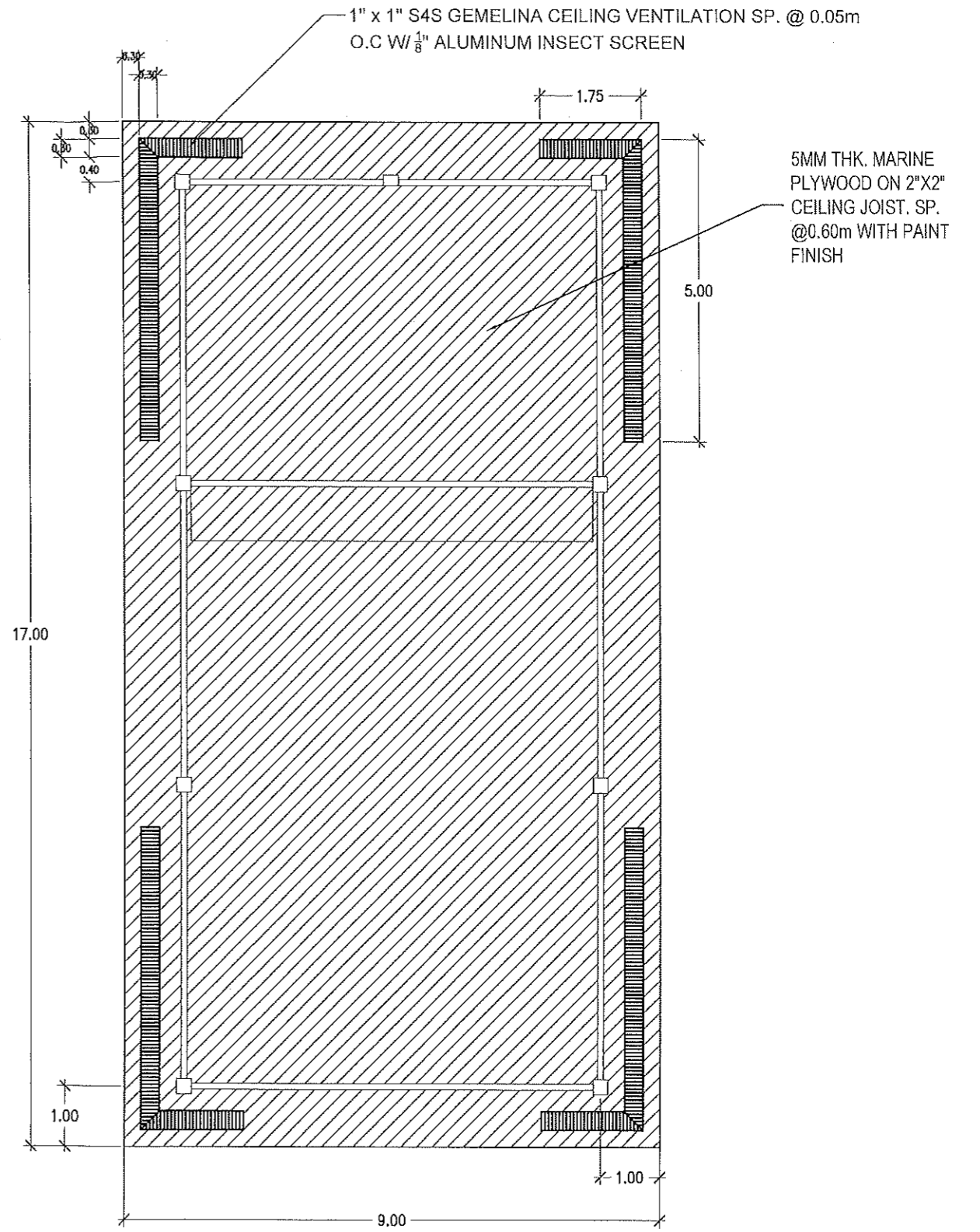

2 REFLECTED CEILING PLAN  
A4 SCALE 1: 100



REPUBLIC OF THE PHILIPPINES  
PROVINCIAL ENGINEER'S OFFICE  
SAN AGUSTIN, DIGOS CITY, DAVAO DEL SUR

PROJECT TITLE:  
CONSTRUCTION OF COVERED SPACE  
WITH STAGE

LOCATION: SAN ISIDRO ELEMENTARY SCHOOL, SAN ISIDRO,  
MAGSAYSAY, DAVAO DEL SUR

PREPARED BY:  
FRANKLIN N. ISLA III  
ENGINEERING ASSISTANT

REVIEWED BY:  
JOSEPH R. GONZALES  
ENGINEER III  
PLANNING AND PROGRAMMING DIV. HEAD

RECOMMENDING APPROVAL:  
ANGELIE R. GELLA  
PGADH - ASSISTANT PROVINCIAL ENGINEER  
OIC - PROVINCIAL ENGINEER  
(AS PER MEMO NO. 22 - 2023)

APPROVED BY:  
YVONNE RONA CAGAS  
PROVINCIAL GOVERNOR

SHEET NO.:

A-4  
413



0.10 m THK. CHB (500 PSI) W/  
PLN CEMENT PLASTER FIN.

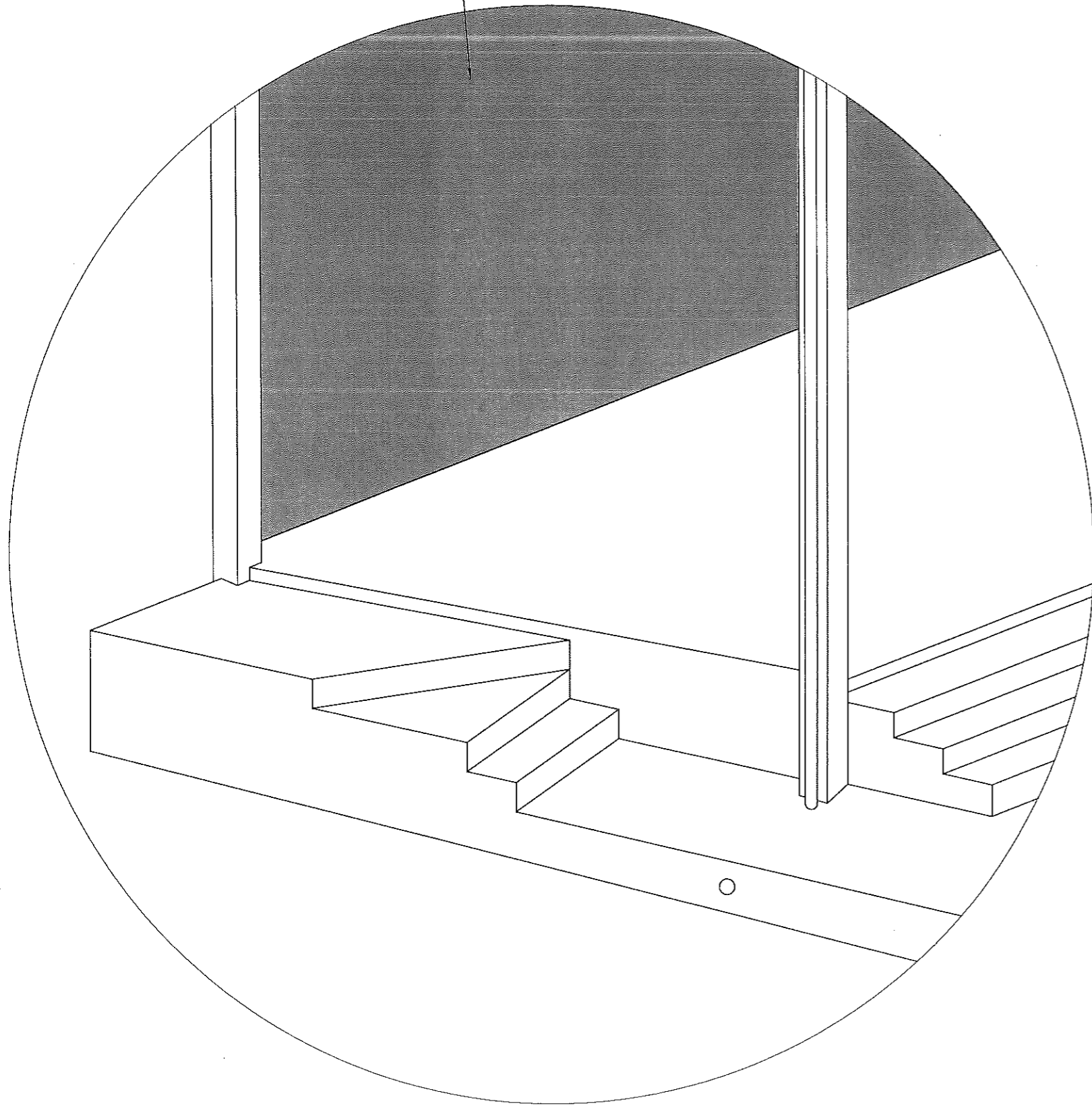

**1 ISOMETRIC VIEW OF STAIRS @ STAGE**  
A-5 SCALE N T S

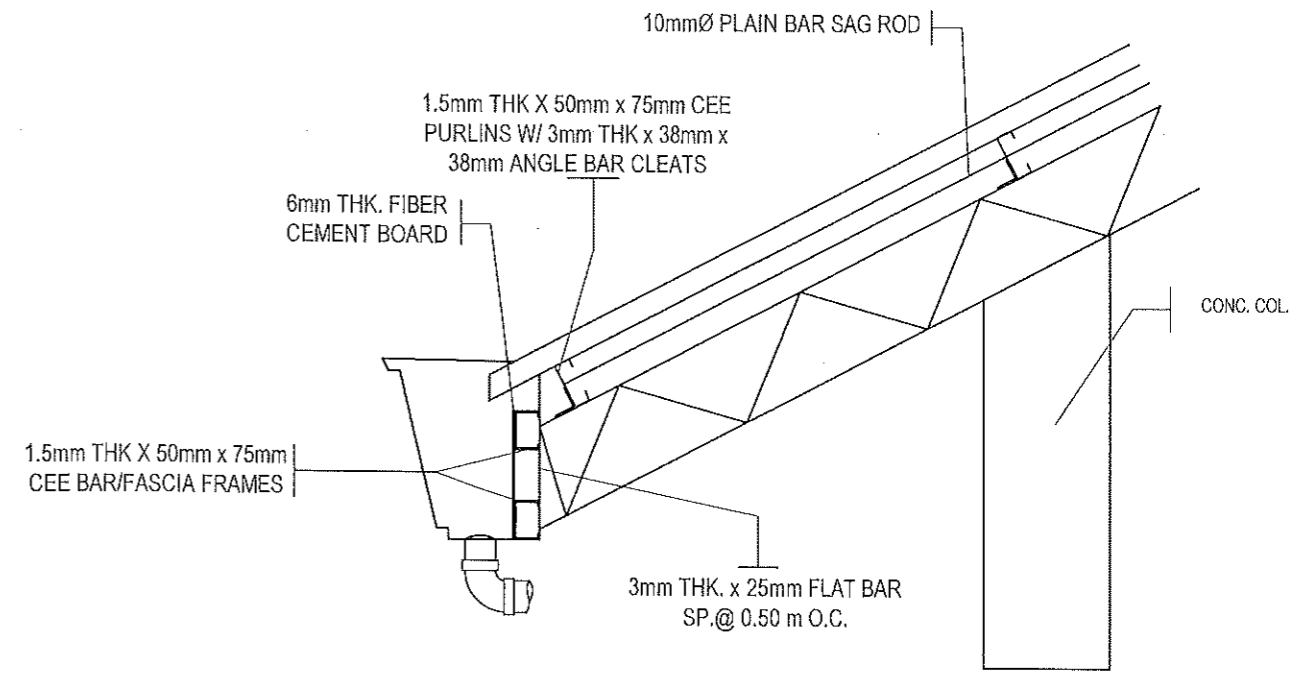

**2 EAVES DETAIL**  
A-5 SCALE N T S

0.427mm THK. PRE-PAINTED, LONG SPAN  
ROOFING (RIB TYPE PROFILE)

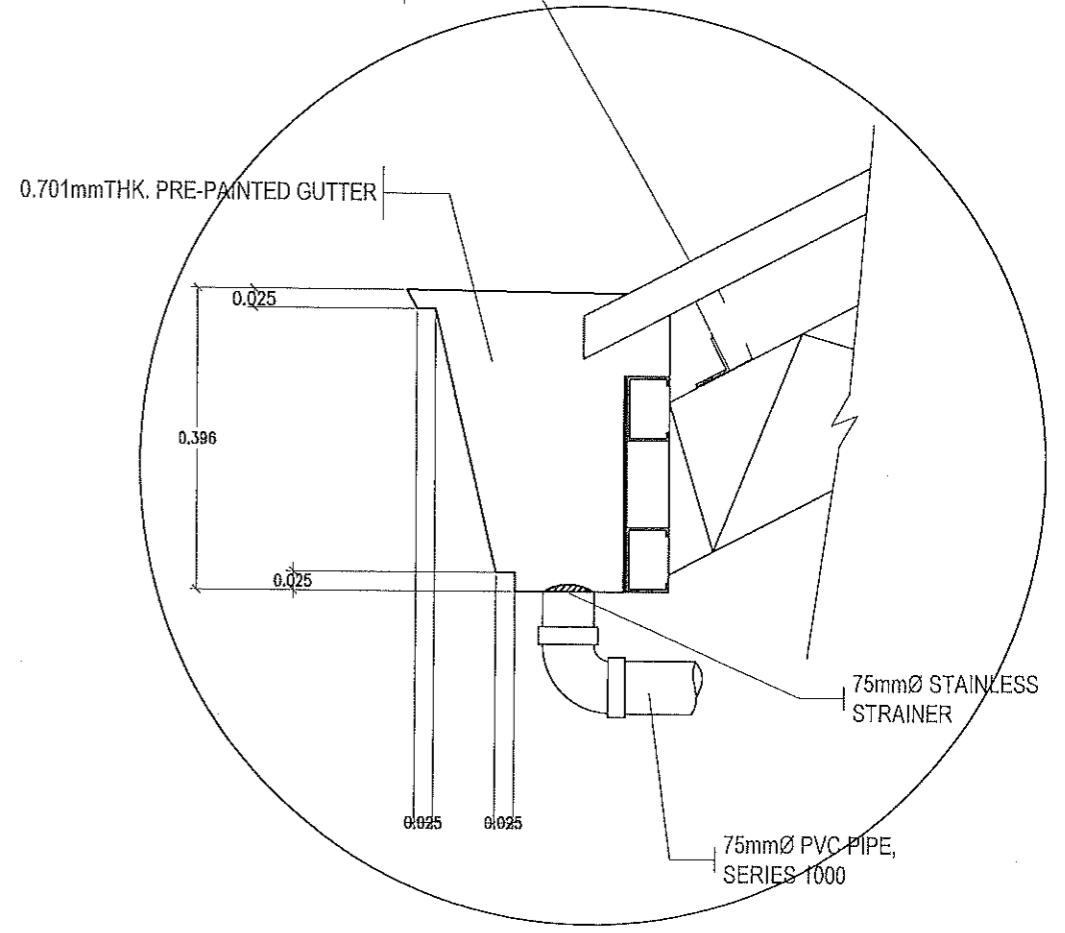

**3 GUTTER DETAILS**  
A-5 SCALE N T S



# GENERAL CONSTRUCTION NOTES

## NOTES ON CONCRETE MIXES & PLACING

### GENERAL NOTES

#### 1.0 STANDARDS AND REFERENCES

- THE FOLLOWING SHALL GOVERN THE DESIGN FABRICATION AND CONSTRUCTION OF THE PROJECT.
- NATIONAL STRUCTURAL CODE OF THE PHILIPPINES (N.S.C.P 2015) VOL. 1, SEVENTH EDITION.
  - SPECIFICATIONS SHALL BE IN ACCORDANCE WITH THE DPWH STANDARD SPECIFICATIONS FOR PUBLIC WORKS STRUCTURES VOLUME III, 2019 EDITION.

#### 2.0 DESIGN CRITERIA

##### 2.1 LOADINGS

###### A. DEAD LOAD

CONCRETE	23.56 kN/m <sup>2</sup>
STEEL	76.93 kN/m <sup>2</sup>
150 mm THK. CHB WALL	2.73 kPa
100 mm THK. CHB WALL	2.11 kPa

###### B. LIVE LOAD

ROOF	1.00 kPa
TOILETS	1.90 kPa
CORRIDORS ABOVE, STAIRS	3.80 kPa
CORRIDORS ON GROUND	4.80 kPa

###### C. WIND LOAD

BUILDING CATEGORY = 1 (ESSENTIAL FACILITIES)  
EXPOSURE = D (FLAT, UNOBSTRUCTED AREAS AND WATER SURFACES)  
MAXIMUM WIND VELOCITY, V = 340 KPH

$$P = qh [(GCpf) / (GCpi)] \quad (\text{DESIGN WIND PRESSURE})$$

WHERE: qh = VELOCITY PRESSURE (kPa)  
GCpf = EXTERNAL PRESSURE COEFFICIENT  
GCpi = INTERNAL PRESSURE COEFFICIENT

###### D. SEISMIC LOAD

$$V = \frac{Cv}{RT} W \quad (\text{DESIGN BASE SHEAR})$$

$$V_{max} = \frac{2.50 C_a W}{R T} \quad V_{min} = 0.11 C_a W$$

$$V_{min} = \frac{0.80 Z N_v W}{R} \quad (\text{ZONE 4})$$

WHERE: W = TOTAL DEAD LOAD  
T = NATURAL PERIOD = Ct (h)  
WHERE: C = NUMERICAL COEFFICIENT  
h = BUILDING HEIGHT  
I = IMPORTANCE FACTOR = 1.50  
R = NUMERICAL FACTOR = 8.50  
SEISMIC COEFFICIENT Cv = 0.44 Nv  
Ca = 0.64 Nv  
NEAR SOURCE FACTOR (5 km) Nv = 1.6  
Na = 1.2  
Z = SEISMIC ZONE = 0.40 (ZONE 4)  
S = SOIL TYPE = D

#### 2.2 DESIGN STRESSES

##### A. CONCRETE COMPRESSIVE STRENGTH @ 28 DAYS:

- FOOTINGS, COLUMNS, BEAMS AND SLABS  $f_c = 20.7 \text{ MPa (3,000 psi)}$
- SLAB ON FILL  $f_c = 17.5 \text{ MPa (2,500 psi)}$

##### B. REINFORCING STEEL BARS

- FOR BARS 16mm AND GREATER (INTERMEDIATE GRADE DEFORMED BAR)  $f_y = 275 \text{ MPa (40,000 psi)}$
- FOR BARS LESS THAN 16mm (STRUCTURAL GRADE DEFORMED BAR)  $f_y = 230 \text{ MPa (33,000 psi)}$

##### C. STRUCTURAL STEEL ASTM-A36

FOR TRUSSES, BRACINGS, & STRUTS  $f_y = 248 \text{ MPa (36,000 psi)}$

##### D. PURLINS

COLD FORMED LIGHT  $f_y = 246 \text{ MPa (36,000 psi)}$

##### E. MASONRY UNIT (CHB)

NON - LOADING BEARING CHB WALLS  $f_m = 3.45 \text{ MPa (500 psi)}$

##### F. WELDS

E - 60XX ELECTRODE  $f_t = 96.80 \text{ MPa (14,000 psi)}$

##### G. STRUCTURAL BOLTS ASTM-A307

a.  $F_u = 69.00 \text{ MPa (10,000 psi)}$   
b.  $F_v = 69.00 \text{ MPa (10,000 psi)}$

#### 3.0 IN THE INTERPRETATION OF THE DRAWING, INDICATED DIMENSIONS SHALL GOVERN.

DISTANCES AND SIZES SHALL NOT BE SCALED FOR CONSTRUCTIONS PURPOSES

#### 4.0 IN REFERENCES TO OTHER DRAWINGS, SEE ARCHITECTURAL DRAWINGS FOR DEPRESSIONS IN FLOOR

SLABS, OPENINGS IN THE WALLS AND SLABS, INTERIOR PARTITIONS, LOCATIONS OF DRAINS ETC.

#### 5.0 IN CASE OF DISCREPANCIES AS TO THE LAYOUT, DIMENSIONS AND ELEVATIONS BETWEEN THE

STRUCTURAL PLANS AND ARCHITECTURAL DRAWINGS, THE CONTRACTORS SHALL NOTIFY BOTH THE STRUCTURAL ENGINEER AND ARCHITECTS.

#### 6.0 ALL CONCRETE WORKS AND CONCRETE REINFORCEMENTS SHALL BE DONE IN ACCORDANCE WITH THE

ACI 318 95 BUILDING CODE REQUIREMENT AND ALL STRUCTURAL STEEL WORKS ACCORDING WITH THE AISC SPECIFICATION (9TH EDITION) SO FAR AS THEY DO NOT CONFLICT WITH THE LOCAL BUILDING CODE REQUIREMENT.

#### 7.0 ACI REFERS TO AMERICAN CONCRETE INSTITUTE, AISC REFERS TO AMERICAN INSTITUTE OF STEEL

CONSTRUCTION AND ASTM REFERS TO AMERICAN SOCIETY FOR TESTING MATERIALS.

#### 8.0 CONSTRUCTION NOTES AND TYPICAL DETAILS APPLY TO ALL DRAWINGS UNLESS OTHERWISE SHOWN OR

NOTED. MODIFY TYPICAL DETAILS AS DIRECTED TO MEET SPECIAL CONDITIONS.

#### 9.0 SHOP DRAWING WITH ERECTION AND PLACING DIAGRAMS OF ALL STRUCTURAL STEELS, MISCELLANEOUS

IRON, PRE-CAST CONCRETE, ETC. SHALL BE SUBMITTED FOR ENGINEERS APPROVAL BEFORE FABRICATION.

#### 10. CONTRACTOR SHALL NOTE AND PROVIDE ALL MISCELLANEOUS CURBS, SILLS, STOOLS EQUIPMENT AND

MECHANICAL BASES THAT ARE REQUIRED BY THE ARCHITECTURAL, ELECTRICAL AND MECHANICAL DRAWINGS.

#### 11. ALL RESULTS OF THE MATERIAL TESTING FOR CONCRETE, REINFORCING BARS & STRUCTURAL STEEL MUST

BE NOTED & APPROVED BY THE MATERIALS ENGINEER/STRUCTURAL DESIGNER.

#### 1. USE TYPE 1 PORTLAND CEMENT FOR STRUCTURAL CONCRETE.

2. ALL CONCRETE SHALL DEVELOP A MIN. COMPRESSIVE STRENGTH AT THE END OF TWENTY EIGHT (28) DAYS W/ CORRESPONDING MAXIMUM SIZE AGGREGATE & SLUMP AS FOLLOWS.

LOCATION	28 DAYS STRENGTH	MAX. SIZE OF AGGREGATE	MAX SLUMP
ALL OTHERS, INCLUDING SUSPENDED SLABS	3000 PSI (20.7 MPa)	20 mm	100mm
COLUMNS	3000 PSI (20.7 MPa)	20 mm	100mm
BEAMS, SLABS	3000 PSI (20.7 MPa)	20 mm	100mm
SLAB ON FILL	2500 PSI (17.5 MPa)	20 mm	100mm

#### 3. MAINTAIN MINIMUM CONCRETE COVER FOR REINFORCING STEEL AS FOLLOWS.

SUSPENDED SLABS	20mm
SLAB ON GRADE	40mm
WALLS ABOVE THE GRADE	25mm
BEAM STIRRUPS AND COLUMN TIES WHERE CONCRETE IS EXPOSED TO EARTH BUT POURED AGAINST FORMS	50mm
WHERE CONCRETE IS DEPOSITED DIRECTLY AGAINST EARTH	75mm

4. CONCRETE SHALL BE DEPOSITED IN ITS FINAL POSITION WITHOUT SEGREGATION. RE-HANDLING OR PLACING SHALL BE DONE PREFERABLY WITH BUGGIES, BUCKETS OR WHEELBARROWS, NO CHUTES WILL BE ALLOWED EXCEPT TO TRANSFER CONCRETE FROM HOPPERS TO BUGGIES, WHEELBARROWS OR BUCKETS IN WHICH CASE THEY SHALL NOT EXCEED SIX (6) METERS IN AGGREGATE LENGTH.

5. NO DEPOSITING OF CONCRETE SHALL BE ALLOWED WITHOUT THE USE OF VIBRATORS UNLESS AUTHORIZED IN WRITING DESIGNER AND ONLY FOR UNUSUAL CONDITIONS WHERE VIBRATIONS ARE EXTREMELY DIFFICULT TO ACCOMPLISH.

6. ALL ANCHOR BOLTS, DOWELS, AND OTHER INSERTS SHALL BE PROPERLY POSITIONED & SECURED IN PLACE PRIOR TO PLACING OF CONCRETE.

7. ALL CONCRETE SHALL BE KEPT MOST FOR A MINIMUM OF SEVEN CONSECUTIVE DAYS IMMEDIATELY AFTER POURING BY THE USE OF WET BURLAP, FOG SPRAYING, CURING COMPOUNDS OR OTHER APPROVED METHODS.

#### 8. STRIPPING OF FORMS AND SHORES:

FOUNDATION	24 HOURS
SUSPENDED SLAB EXCEPT WHEN ADDITIONAL LOADS ARE IMPOSED	8 DAYS
WALLS	21 DAYS
BEAMS	14 DAYS
COLUMNS	21 DAYS

9. THE CONTRACTOR SHALL SUBMIT THE SCHEDULE OF POURING AND THE LOCATION OF THE CONSTRUCTION JOINTS TO THE STRUCTURAL ENGINEER AT LEAST (4) DAYS PRIOR TO THE POURING FOR APPROVAL.

10. THE CONTRACTOR SHALL FURNISH AND MAINTAIN ADEQUATE FORMS AND SHORINGS UNTIL THE CONCRETE MEMBERS HAVE ATTAINED THEIR WORKING CONDITION AND STRENGTH.

### NOTES ON FOOTINGS

- FOOTINGS ARE DESIGNED FOR AN ALLOWANCE SOIL BEARING PRESSURE OF 96 KPa (2000psi). CONTRACTOR SHALL REPORT TO THE ENGINEER, IN WRITING, THE ACTUAL SOIL CONDITIONS UNCOVERED AND CONFIRM ACTUAL BEARING CAPACITY OF SOIL BEFORE DEPOSITING CONCRETE.
- FOOTING SHALL REST AT LEAST 150mm BELOW NATURAL GRADE LINE UNLESS OTHERWISE INDICATED IN PLANS. NO FOOTING SHALL REST ON FILL.
- MINIMUM CONCRETE PROTECTION FOR REINFORCEMENT SHALL BE 75mm CLEAR FOR CONCRETE DEPOSITED THE GROUND AND 50mm FOR CONCRETE DEPOSITED AGAINST A FORMWORK.
- IN CASES WHERE THE SOIL CONDITION IS SUCH THAT THE MINIMUM ALLOWABLE SOIL PRESSURE OF 96KPa (2000 psi) CAN NOT BE ATTAINED AT A PRACTICAL DEPTHS THE USE OF MICROPILES, BORED PILES, OR DRIVEN PILES MAY BE ADOPTED IN LIEU OF STANDARD ISOLATED FOOTINGS.

### NOTES ON REINFORCEMENT

- UNLESS OTHERWISE NOTED IN PLANS, THE YIELD STRENGTH OF REINFORCING BARS SHALL BE:
  - FOOTINGS, FOOTING BEAMS AND GIRDERS  $f_y = 275 \text{ MPa (40,000 psi)}$
  - COLUMNS AND SHEAR WALLS  $f_y = 275 \text{ MPa (40,000 psi)}$
  - BEAMS AND GIRDER  $f_y = 275 \text{ MPa (40,000 psi)}$
  - NON-LOAD BEARING WALL PARTITIONS, BEDDED SLABS, FLOOR & ROOF SLABS, PARAPETS, CATCH BASIN, SIDE WALK  $f_y = 275 \text{ MPa (40,000 psi)}$
- ALL REINFORCING BARS SIZE 10mm OR LARGER SHALL BE DEFORMED IN ACCORDANCE WITH THE ASTM A-705 BARS SMALLER THAN 10mm MAY BE PLAIN.
- SPLICES SHALL BE SECURELY WIRED TOGETHER & SHALL LAP OR EXTEND IN ACCORDANCE w/ TABLE B (TABLE OF LAP SPLICE & ANCHORAGE LENGTH) UNLESS OTHERWISE SHOWN ON DRAWINGS, SPLICES SHALL BE STAGGERED WHENEVER POSSIBLE.

### NOTES ON CONCRETE SLABS

- ALL SLAB REINFORCEMENTS SHALL BE 20mm CLEAR MINIMUM FROM BOTTOM AND FROM THE TOP OF SLAB.
- UNLESS OTHERWISE SHOWN, REINFORCEMENT IN CONTINUOUS ELEVATED SLAB SHALL BE CUT AS FOLLOWS:

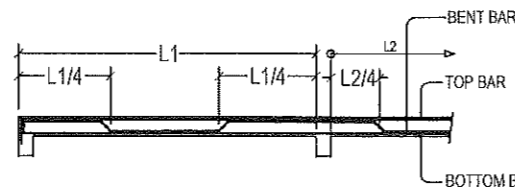

3. IF SLABS ARE REINFORCED BOTHWAYS BARS ALONG THE SHORTER SPAN SHALL BE PLACED BELOW THOSE ALONG THE LONG SPAN AT THE CENTER AND OVER THE LONGER SPAN FOR REINFORCING BARS NEAR THE SUPPORTS. THE SPACING OF THE BARS AT THE COLUMN STRIPS SHALL NOT BE MORE THAN ONE AND A HALF (1 1/2) SLAB THICKNESS.

4. TEMPERATURE BARS FOR SLAB SHALL BE GENERALLY PLACED NEAR THE FACE IN TENSION AND SHALL NOT BE LESS THAN 0.0025 X GROSS-SECTIONAL AREA (Ag) OF THE SLAB. (SEE SCHEDULE BELOW)

SCHEDULE OF MINIMUM SLAB REINFORCEMENT	
MINIMUM TEMPERATURE BARS	
100 mm	10mm Ø @ 250mm EACH WAY
125 mm	10mm Ø @ 250mm EACH WAY
150 mm	10mm Ø @ 250mm EACH WAY
175 mm	10mm Ø @ 250mm EACH WAY
200 mm	10mm Ø @ 250mm EACH WAY

5. UNLESS OTHERWISE NOTED IN THE PLANS ALL BEDDED SLABS SHALL BE REINFORCED WITH 10mm Ø AT 250mm O.C. EACH WAY TO CENTER OF SLAB AND CONSTRUCTION JOINTS FOR SAME SHALL NOT BE LESS THAN 3.65 METER APART.

6. PROVIDE EXTRA REINFORCEMENTS FOR CORNER SLAB (TWO ADJACENT DISCONTINUES EDGES) AS SHOWN BELOW.

7. CONCRETE SLAB REINFORCEMENT BE PROPERLY SUPPORTED WITH 10mm STEEL CHAIR OR APPROVED EQUIVALENT SPACED AT 1.0 METER ON CENTER BOTHWAYS.

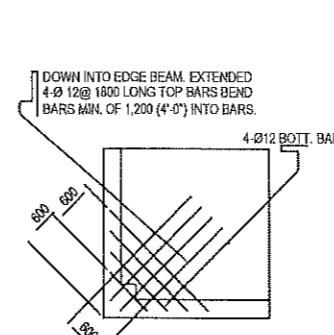

TYPICAL CORNER SLAB DETAIL

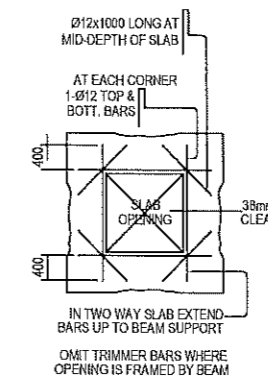

TYPICAL SLAB OPENING DET.

### NOTES ON COLUMNS

- PROVIDE EXTRA SETS OF TIES AT 100 O.C. FOR TIED COLUMN REINFORCEMENT ABOVE AND BELOW BEAM-COLUMN CONNECTIONS FOR A DISTANCE FROM FACE OF CONNECTION EQUAL TO GREATER OF THE OVERALL THICKNESS OF COLUMN, 1/6 THE CLEAR HEIGHT OF COLUMN OR 450mm.
- COLUMN TIES SHALL BE PROTECTED EVERYWHERE BY A COVERING OF CONCRETE CAST MONOLITHICALLY WITH THE CORE WITH A MINIMUM THICKNESS OF 40mm AND NOT LESS THAN 40 TIMES THE MAXIMUM SIZE OF COARSE AGGREGATE IN MILLIMETERS.
- WHERE COLUMNS CHANGE IN SIZE, VERTICAL REINFORCEMENT SHALL BE OFFSET AT A SLOPE MONOLITHICALLY WITH THE CORE WITH MINIMUM THICKNESS OF 40mm AND NOT LESS THAN 40 TIMES THE MAXIMUM SIZE COARSE AGGREGATE IN MILLIMETERS
- UNLESS OTHERWISE INDICATED IN THE PLANS, LAP SPLICES FOR VERTICAL COLUMN REINFORCEMENT SHALL BE MADE WITHIN THE CENTER HALF OF COLUMN HEIGHT, AND THE SPLICE LENGTH SHALL BE LESS THAN 40 BAR DIAMETERS. WELDING OR APPROVED MECHANICAL DEVICES MAY BE USED PROVIDED THAT NOT MORE THAN ALTERNATE BARS ARE WELDED OR MECHANICALLY SPLICED AT ANY LEVEL AND THE VERTICAL DISTANCES BETWEEN THESE BARS OR SPLICES OF ADJACENT BARS IS NOT LESS THAN 600mm.

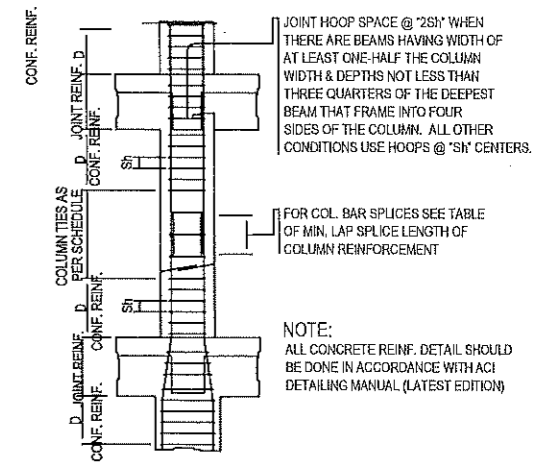
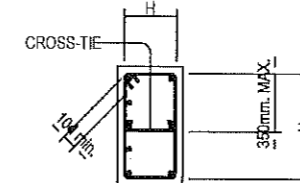

TYPICAL COLUMN ELEV. SHOWING DOWELS AND TIES SPACING

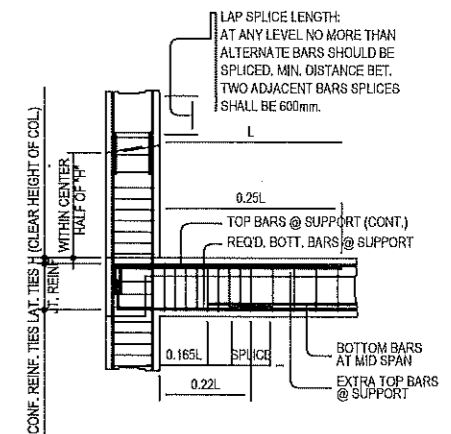

TYP. DETAIL OF COL. LAP SPLICE & EXT. GIRDER TO COL. CONNECT.

### NOTES ON BEAMS AND GIRDERS

- UNLESS, OTHERWISE NOTED IN PLANS, CAMBER ALL BEAMS AND GIRDER AT LEAST 6mm Ø FOR EVERY 4.50 M OF SPAN, EXCEPT CANTILEVERS FOR WHICH THE CAMBER SHALL BE AS NOTED IN PLANS OR AS ORDERED BY THE ENGINEER BUT IN NO CASE LESS THAN 20 mm FOR EVERY 3.0 M OF FREE SPAN.
- TYPICAL BARS BENDING AND CUTTING DETAILS FOR BEAMS SHALL BE AS SHOWN IN FIG. B-1

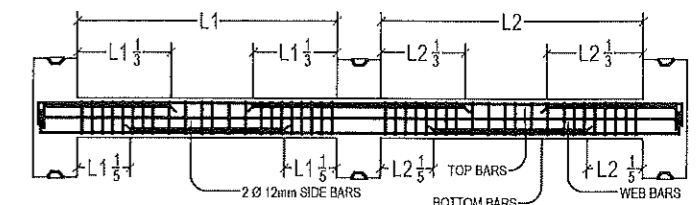

FIGURE B-1

# GENERAL CONSTRUCTION NOTES

**TABLE 'A'**  
TENSION BARS  
TABLE OF LAP SPLICE & ANCHORAGE LENGTH (mm)

BAR SIZES (DEFORMED)	f <sub>c</sub> = 20.7 MPa (300psi)		f <sub>c</sub> = 27.6 MPa (400psi)	
	EMBEDMENT	LAPPED	EMBEDMENT	LAPPED
Ø10	300	360	360	360
Ø12	360	360	360	360
Ø16	360	400	360	400
Ø20	400	550	350	500
Ø25	600	600	550	750
Ø28	750	1000	650	850
Ø32	950	1300	850	1100

NOTES:  
1. TOP PLAIN BARS, MULTIPLY VALUE BY 2  
2. NOT MORE THAN 33% OF THE BARS SHALL BE SPLICED WITHIN THE REQUIRED LAP LENGTH

**TABLE 'B'**  
COMPRESSION BARS  
TABLE OF LAP SPLICE & ANCHORAGE LENGTH (mm)

BAR SIZES (DEFORMED)	f <sub>c</sub> = 20.7 MPa (300psi)		f <sub>c</sub> = 27.6 MPa (400psi)	
	EMBEDMENT	LAPPED	EMBEDMENT	LAPPED
Ø10	275	300	200	300
Ø12	275	300	250	300
Ø16	350	400	325	400
Ø20	450	500	475	500
Ø25	550	625	550	625
Ø28	625	675	625	675
Ø32	700	775	700	775

NOTES:  
1. TOP PLAIN BARS, MULTIPLY VALUE BY 2  
2. NOT MORE THAN 33% OF THE BARS SHALL BE SPLICED WITHIN THE REQUIRED LAP LENGTH  
3. VALUES GIVEN ABOVE CAN ALSO BE USED FOR COLUMNS

## REINFORCING CONCRETE LINTEL BEAMS IN CONCRETE BLOCK WALLS

**LINTELS IN BLOCK WALLS**

CLEAR SPAN (L)	TOTAL LENGTH (L+0.40M)	MIN. f <sub>c</sub> (MPa)	HEIGHT OF LINTEL (mm)	REINFORCEMENT		
				BOTTOM	TOP	STIRRUPS
1.20 M	1.60 M	14.0	200	1-Ø10	1-Ø10	Ø5 mm @ 200mm
1.50 M	1.90 M		200	1-Ø10	1-Ø10	Ø5 mm @ 200mm
1.80 M	2.20 M		200	1-Ø12	1-Ø10	Ø5 mm @ 200mm
2.10 M	2.50 M	17.0	250	1-Ø12	1-Ø10	Ø5 mm @ 200mm
2.40 M	2.80 M		250	1-Ø12	1-Ø10	Ø5 mm @ 200mm
2.70 M	3.10 M		250	1-Ø16	1-Ø12	Ø10mm @ 200mm
3.00 M	3.40 M	20.0	300	1-Ø16	1-Ø12	Ø10mm @ 200mm
3.30 M	3.70 M		300	1-Ø16	1-Ø12	Ø10mm @ 200mm
3.60 M	4.00 M		300	1-Ø20	1-Ø12	Ø10mm @ 200mm

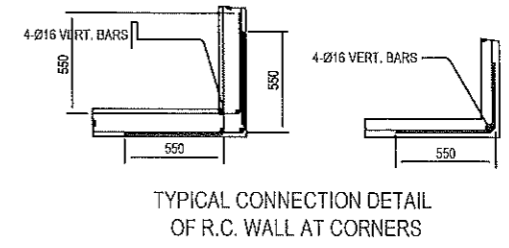
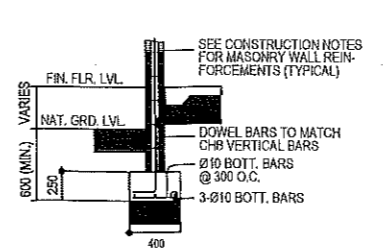

- NOTES ON STIRRUPS**
1. ALL REINFORCEMENT SHALL BE BENT COLD UNLESS OTHERWISE PERMITTED BY THE STRUCTURAL ENGINEER.
  2. AS SHOWN IN THE DESIGN DRAWINGS OR PERMITTED BY THE STRUCTURAL ENGINEER.
  3. TIES & CLOSE STIRRUPS MUST BE AT 135.

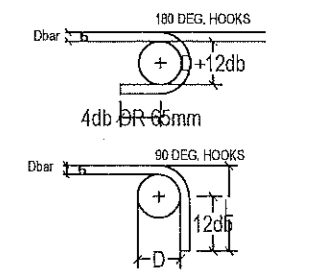

- NOTES ON WELDS**
1. USE E60xx ELECTRODES FOR ALL MEMBERS WELDED.
  2. WELDS SHALL DEVELOP THE FULL STRENGTH OF MEMBERS JOINED UNLESS OTHERWISE SHOWN OR DETAILED IN THE DRAWINGS.

- NOTES ON STRUCTURAL STEEL**
1. STRUCTURAL STEEL TO BE USED FOR FABRICATION AND ERECTION OF THIS STRUCTURE SHALL COMPLY WITH ALL THE PERTINENT PROVISIONS OF AISC SPECIFICATION FOR THE DESIGN, FABRICATION AND ERECTION OF STRUCTURAL STEEL FOR BUILDING LATEST EDITION.
  2. ALL STRUCTURAL STEEL SHAPES SHALL CONFORM TO ASTM A36 STRUCTURAL STEEL UNLESS OTHERWISE INDICATED.
  3. ALL WELDED CONNECTIONS SHALL DEVELOP THE FULL STRENGTH OF THE MEMBERS CONNECTED.
  4. UNLESS OTHERWISE SPECIFIED ALL WELDING RODS SHALL CONFORM WITH E60 ELECTRODES.
  5. ALL BOLTS USED UNLESS OTHERWISE SPECIFIED SHALL BE ASTM A307 BOLTS.

**MANY BAR END HOOKS (ALL GRADES)**

BAR SIZE (DEFORMED)	DIAMETER (mm)	180° HOOK		90° HOOK	
		D+2db	L	L	L
10 mm Ø	60	75	125	150	
12 mm Ø	75	100	150	200	
16 mm Ø	95	125	175	250	
20 mm Ø	115	150	200	300	
25 mm Ø	150	200	250	450	
28 mm Ø	240	300	350	550	
32 mm Ø	300	335	450	600	

3. IF THE BEAM REINFORCING BARS END IN A WALL, THE CLEAR DISTANCE FROM THE BAR TO THE FARTHER FACE OF THE WALL IS NOT LESS THAN 25mm. EMBEDMENT LENGTH SHALL BE SHOWN IN A TABLE 'A' FOR TENSION BARS AND TABLE 'B' FOR COMPRESSION BARS UNLESS SPECIFIED IN PLAN. TOP BARS AND SHALL NOT BE SPLICED WITHIN THE COLUMN OR TWO STIRRUPS SHALL BE PROVIDED AT ALL SPLICES.
4. IF THERE ARE TWO OR MORE LAYERS OF REINFORCING BARS, USED 25mm BAR SEPARATORS SPACED AT 1.0M ON CENTER ON NO CASE SHALL THERE BE THAN TWO (2) SEPARATORS BETWEEN LAYERS OF BARS
5. MINIMUM CONCRETE PROTECTION FOR REINFORCING BARS OR STEEL SHAPES SHALL BE AS SHOWN IN FIGURE B-2 UNLESS ELSEWHERE.

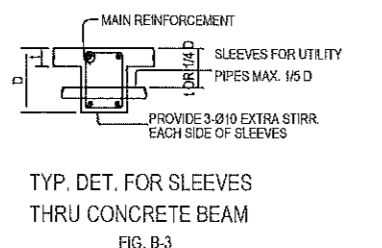
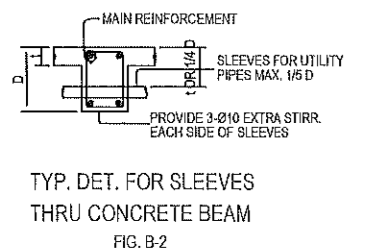

6. WHEN A BEAM CROSSES A GIRDER, REST BEAM ON TOP OF GIRDER BARS, BEAM REINFORCING BARS SHALL BE SYMMETRICAL ABOUT THE CENTER LINE WHENEVER POSSIBLE.
7. GENERALLY, NO SPLICES SHALL BE PERMITTED AT POINTS WHERE CRITICAL BENDING STRESSES OCCUR, SPLICES WHERE SO PERMITTED SHALL BE INDICATED IN TABLE 'A' AND 'B'. WELDED SPLICES SHALL DEVELOP IN TENSION AT LEAST 125% OF THE SPLICED YIELD STRENGTH OF THE BAR NOT MORE THAN 50% OF THE BARS AT ANY ONE SECTION IS ALLOWED TO BE SPLICED THEREIN.

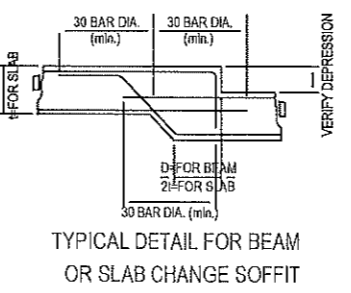
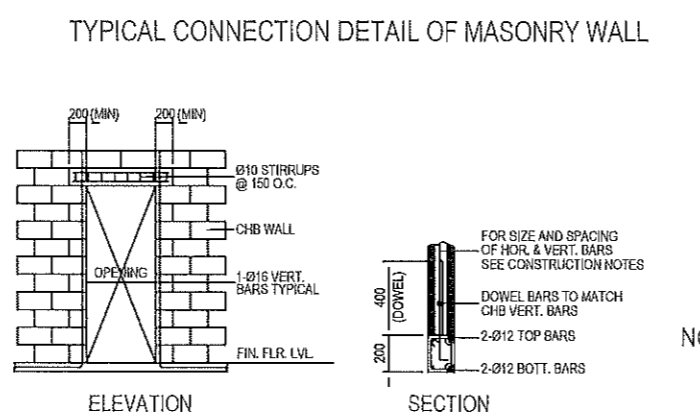
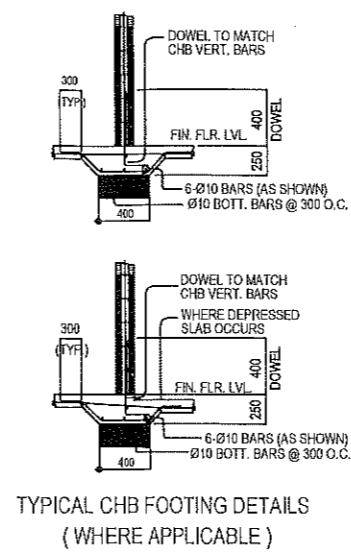
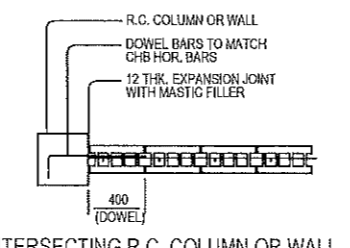
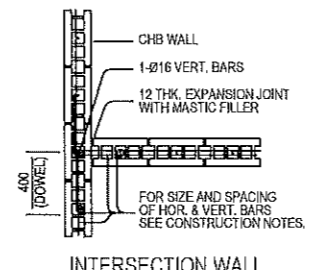
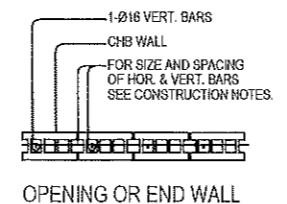
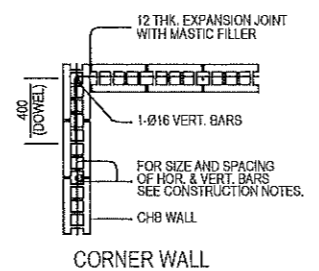

- NOTES ON EMBEDDED PIPES**
1. ALL EMBEDDED PIPES FOR UTILITIES ETC. THAT PASS THRU BEAMS SHALL NOT EXCEED 100mm IN DIAMETER OR 1/3 BEAM DEPTH WHICHEVER IS LESS, UNLESS OTHERWISE APPROVED IN WRITING BY THE STRUCTURAL ENGINEER.
  2. NO PIPES SHALL BE ALLOWED TO PASS THRU BEAMS VERTICALLY.
  3. NO PIPES SHALL BE EMBEDDED IN COLUMNS.
- NOTES ON CONSTRUCTION JOINTS IN CONCRETE**
1. WHERE A CONSTRUCTION JOINT IS TO BE MADE, THE SURFACE OF CONCRETE SHALL BE CLEANED AND ALL LAITANCE AND STANDING WATER REMOVED SHEAR KEY SHALL BE PROVIDE AT THE JOINT.

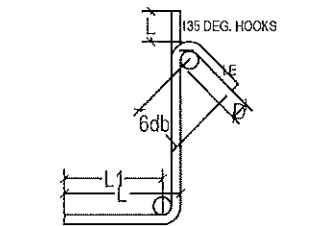
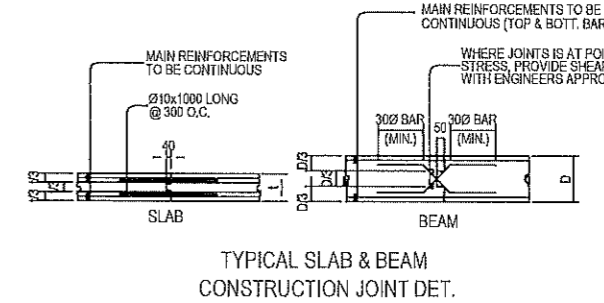

**STIRRUP AND TIE HOOKS (ALL GRADES)**

BAR SIZE (DEFORMED)	DIAMETER (mm)	180° HOOK		90° HOOK	
		D+2db	L	L	L
10 mm Ø	40	125	65	100	
12 mm Ø	50	165	115	115	
16 mm Ø	65	200	140	150	
20 mm Ø	115	350	165	300	
32 mm Ø	150	335	230	465	

## NOTES ON CONCRETE HOLLOW BLOCKS WALLS

1. UNLESS OTHERWISE SHOWN IN PLANS ALL CONCRETE HOLLOW BLOCKS AND CERAMIC BLOCKS SHALL BE REINFORCED AS SHOWN IN THE SCHEDULE OF CONCRETE HOLLOW BLOCKS AND CERAMIC BLOCK REINFORCEMENT.
2. PROVIDE 150mm x 300mm STIFFENER COLUMN REINFORCED WITH 4-12mm WITH 10mm Ø TIES AT 150mm ON CENTER WHERE CONCRETE HOLLOW BLOCK TERMINATES AND AT EVERY 3.0M LENGTH OF CONCRETE HOLLOW BLOCK WALLS UNLESS NOTED IN STRUCTURAL PLANS.

**NOTES ON CONCRETE HOLLOW BLOCKS WALLS REINFORCEMENTS**

BLOCK THICKNESS	REINFORCEMENT		NOTES
	HORIZONTAL	LAPPED	
100 mm	10mm Ø EVERY 3RD LEVEL	10mm Ø @ 600mm O.C.	A. MINIMUM LAPS AT SPLICE= 0.25 M B. PROVIDE RIGHT ANGLED REINFORCEMENT AT CORNERS 0.92 m LONG C. WHERE CHB OR CER. BLK. WALL DOWELS WITH THE SAME SIZE AS VER. OR HOR. REINFORCEMENT SHALL BE PROVIDED
125 mm	10mm Ø EVERY 3RD LEVEL	10mm Ø @ 600mm O.C.	
150mm	10mm Ø EVERY 3RD LEVEL	10mm Ø @ 600mm O.C.	
200 mm	12mm Ø EVERY 3RD LEVEL	10mm Ø @ 600mm O.C.	

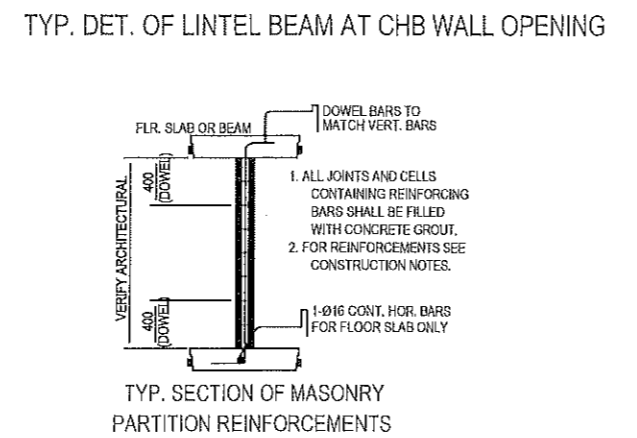

## NOTES ON CONCRETE WALLS

1. ALL WALLS SHALL BE REINFORCED ACCORDING TO THE FOLLOWING SCHEDULE OF WALL REINFORCEMENT UNLESS OTHERWISE INDICATED IN THE PLANS.

WALL THICKNESS	REINFORCEMENT			REMARKS	VERTICAL SECTION
	HORIZONTAL	VERTICAL			
100mm	Ø10mm @ 250mm O.C.	Ø10mm @ 300mm O.C.		HORIZONTAL BARS AT CENTERS VERTICAL BARS STAGGERED OUT	VER. BARS HOR. BARS
125mm	Ø10mm @ 200mm O.C.	Ø10mm @ 250mm O.C.			
150mm	Ø12mm @ 250mm O.C.	Ø12mm @ 300mm O.C.			

- REINFORCING BARS SHALL HAVE 25mm CLEAR CONCRETE COVER FROM FACE OF WALL EXCEPT FOR WALLS IN CONTACT WITH THE GROUND WHERE A MINIMUM OF 60mm SHALL BE PROVIDED AND FOR EXPOSED FACES OF FORMED WALLS WHERE THE MINIMUM SHALL BE 50mm CLEAR.
2. CARRY VERTICAL BARS AT LEAST 60mm ABOVE FLOOR LEVEL TO PROVIDE FOR SPLICES WHEN NECESSARY STOP AT 50mm BELOW TOP SLAB OR SOLID BAND WHERE THE WALL ENDS VERTICAL AND HORIZONTAL BARS SHALL BE SPLICED BY LAPPING A DISTANCE EQUAL TO 3Ø DIAMETERS AND WIRED SECURELY WITH 16 G.I. WIRE PROVIDED THAT SPLICES IN ADJACENT BARS ARE STAGGERED AT LEAST 1.50M O.C.
  3. UNLESS OTHERWISE NOTED IN THE PLANS, ALL OPENINGS IN WALLS 250mm OR THICKER SHALL BE REINFORCED AROUND WITH 2-20mmØ BARS. FOR 225mm, 200mm, 175mm, 150mm THICK WALLS, USE 2-16mmØ. FOR 125mm AND 100mm THICK WALLS, USE 2-12mmØ BARS. ALL WALLS SPANNING SHALL HAVE VERTICAL REINFORCEMENT BENT A U-FORM LIKE STIRRUPS AND SPACED ACCORDING TO THE SCHEDULE UNLESS OTHERWISE NOTED.

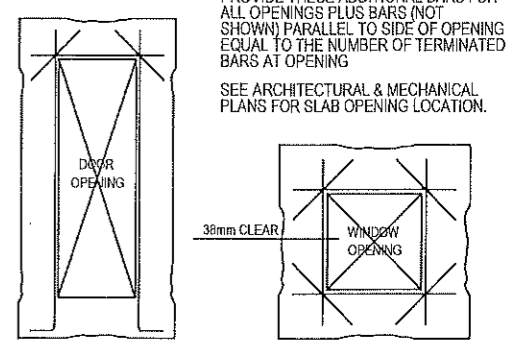

NOTE:  
PROVIDE THESE ADDITIONAL BARS FOR ALL OPENINGS PLUS BARS (NOT SHOWN) PARALLEL TO SIDE OF OPENING EQUAL TO THE NUMBER OF TERMINATED BARS AT OPENING  
SEE ARCHITECTURAL & MECHANICAL PLANS FOR SLAB OPENING LOCATION.

<p>REPUBLIC OF THE PHILIPPINES <b>PROVINCIAL ENGINEER'S OFFICE</b> SAN AGUSTIN, DIGOS CITY, DAVAO DEL SUR</p>	PROJECT TITLE: <b>CONSTRUCTION OF COVERED SPACE WITH STAGE</b>	PREPARED BY: <b>FRANKLIN N. ISLA III</b> ENGINEERING ASSISTANT	REVIEWED BY: <b>JOSEPH R. GONZALES</b> ENGINEER - III PLANNING AND PROGRAMMING DIV. HEAD	RECOMMENDING APPROVAL: <b>ANGELIE R. GELLA</b> PGADH - ASSISTANT PROVINCIAL ENGINEER OIC - PROVINCIAL ENGINEER (AS PER MEMO NO. 22 - 2023)	APPROVED BY: <b>YVONNE RONA CAGAS</b> PROVINCIAL GOVERNOR	SHEET NO.: <b>S-2</b> 7/13
	LOCATION: SAN ISIDRO ELEMENTARY SCHOOL, SAN ISIDRO, MAGSAYSAY, DAVAO DEL SUR					

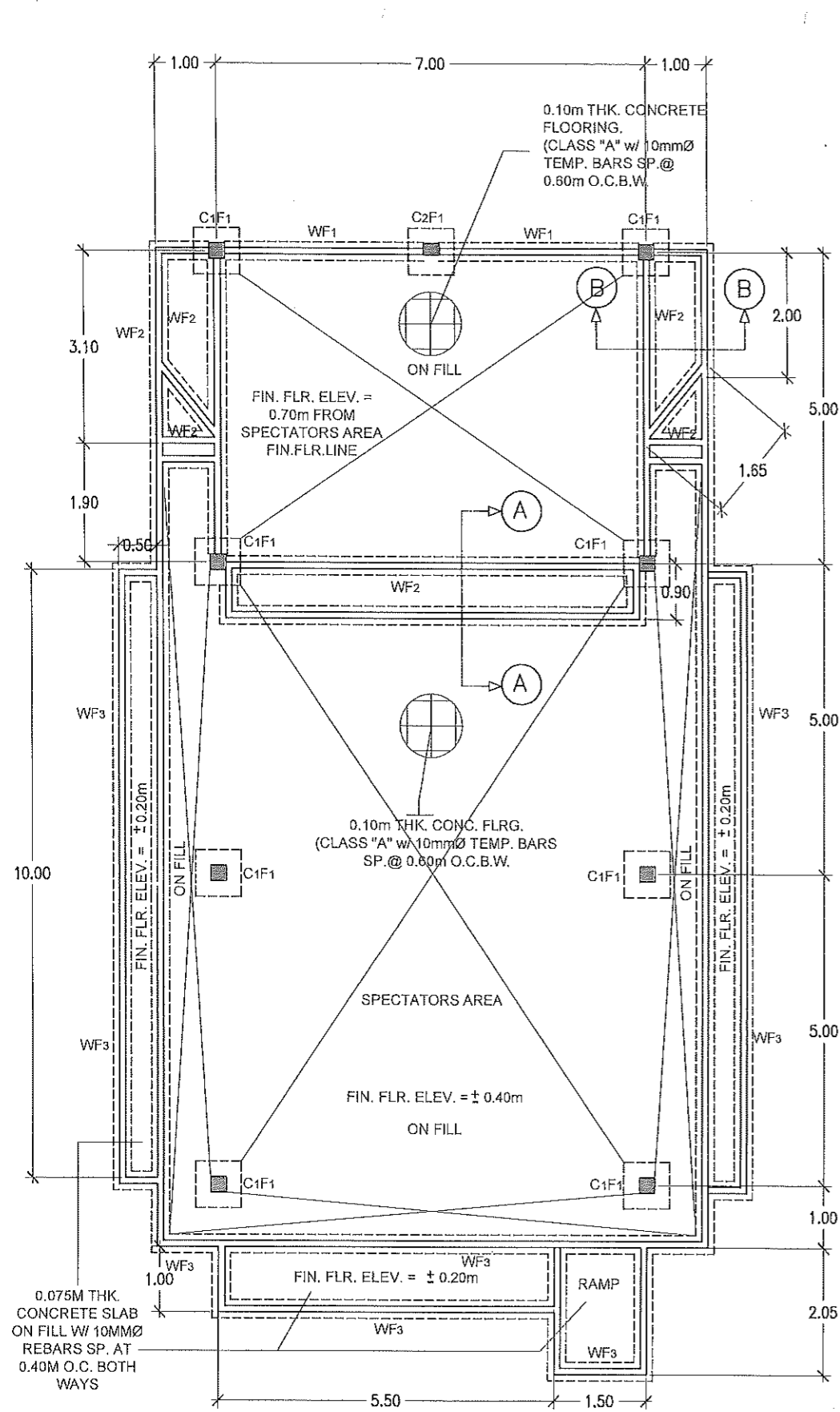

**1 FOUNDATION PLAN**  
SCALE 1:100

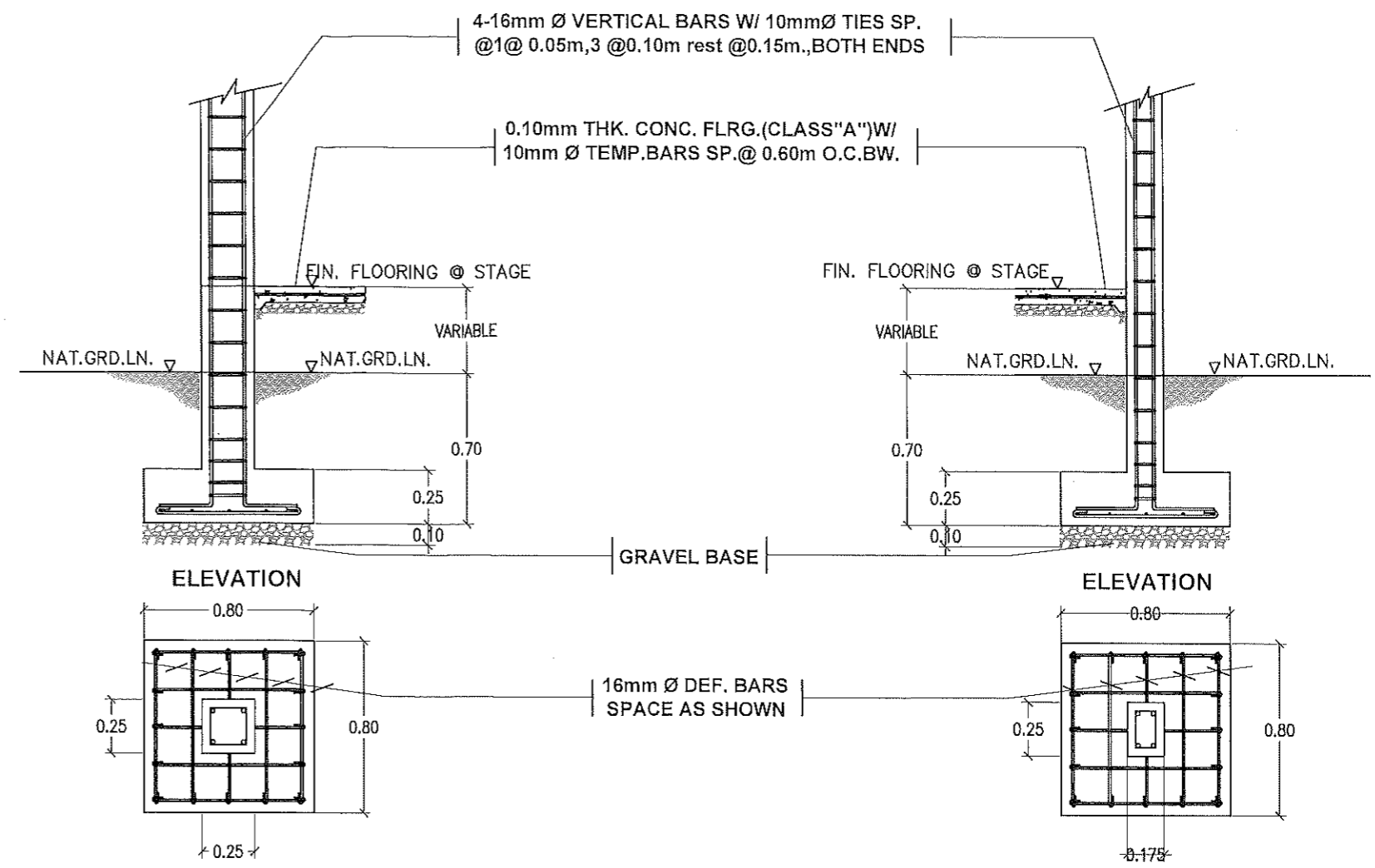

**2 C1F1 DETAILS**  
SCALE 1:30

**3 C2F1 DETAILS**  
SCALE 1:30

**4 SECTION THRU A-A DETAILS**  
SCALE N T S









	PROJECT TITLE: <b>CONSTRUCTION OF COVERED SPACE WITH STAGE</b>	PREPARED BY:  <b>FRANKLIN N. ISLA III</b> ENGINEERING ASSISTANT	REVIEWED BY:  <b>JOSEPH R. GONZALES</b> ENGINEER - III PLANNING AND PROGRAMMING DIV. HEAD	RECOMMENDING APPROVAL:  <b>ANGELIE R. GELIA</b> PGADH - ASSISTANT PROVINCIAL ENGINEER OIC - PROVINCIAL ENGINEER (AS PER MEMO NO. 22 - 2023)	APPROVED BY:  <b>YVONNE RONA CAGAS</b> PROVINCIAL GOVERNOR	SHEET NO.: 
	REPUBLIC OF THE PHILIPPINES <b>PROVINCIAL ENGINEER'S OFFICE</b> SAN AGUSTIN, DIGOS CITY, DAVAO DEL SUR	LOCATION: SAN ISIDRO ELEMENTARY SCHOOL, SAN ISIDRO, MAGSAYSAY, DAVAO DEL SUR				





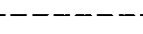

**LEGEND:**

-  SERVICE ENTRANCE
-  KILOWATT HOUR METER
-  PANEL BOARD
-  CIRCUIT HOMERUN
-  TWO GANG SWITCH WITH PLATE, FLUSH TYPE
-  TWO GANG CONVENIENCE OUTLET W/ PLATE, FLUSH TYPE UNIVERSAL TYPE
-  PINLIGHT 6" DIA. ADJUSTABLE CASING RECESSED TYPE WITH 12W LED BULB, DAYLIGHT
-  LIGHTING CKT LINE
-  POWER CKT LINE

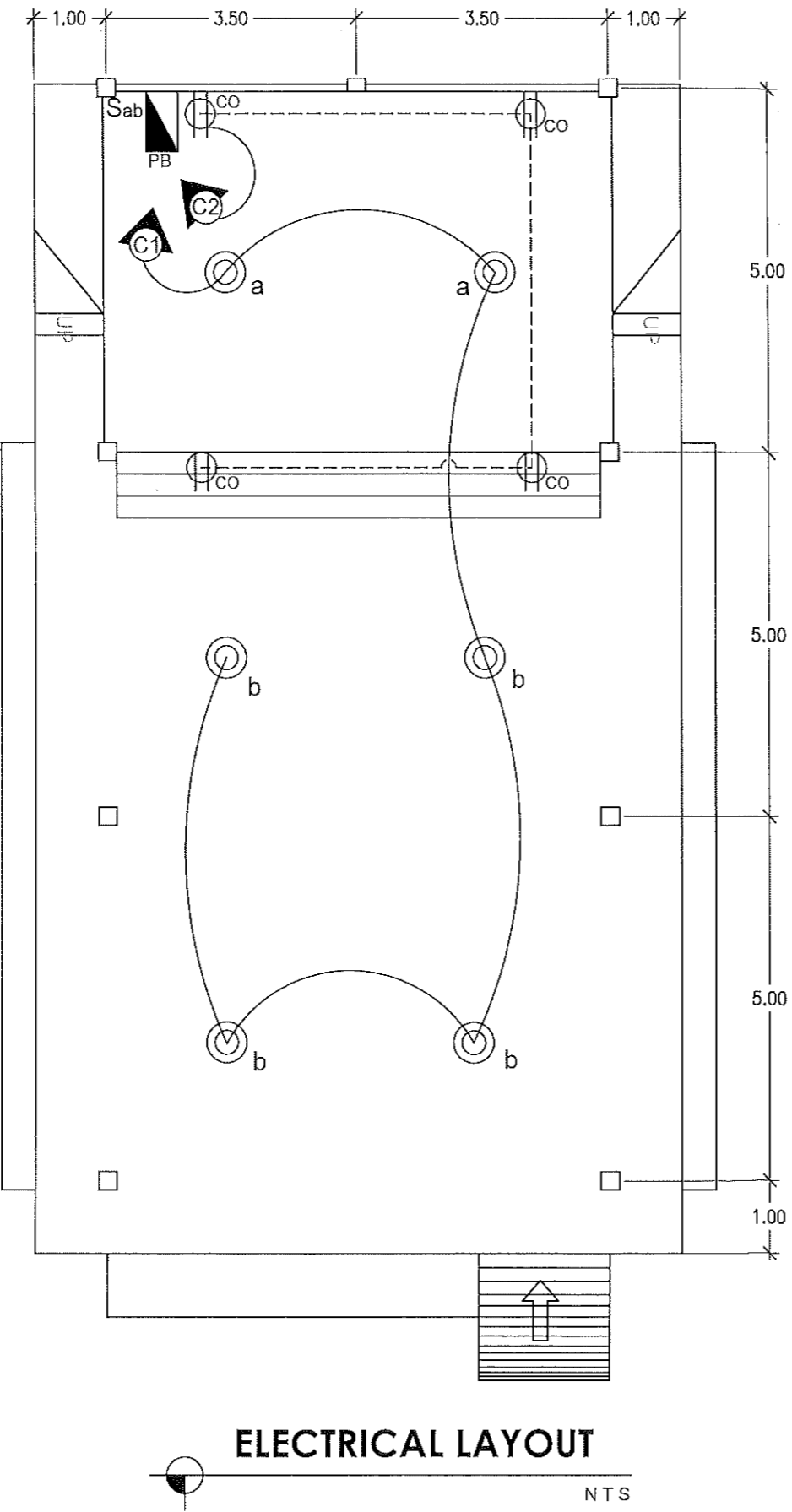

**NOTES & SPECIFICATION:**

All Electrical Installations herein shall be in accordance with the Latest Rules & Regulations of the Philippine Electrical Code and the Local Power Company.

All Electrical materials to be installed herein must be brand new and of approved type & quality.

Wirings passing through concrete masonry, ceilings, columns, beams, slabs must be concealed type using PVC Pipe or Flexible Pipe.

Whenever Necessary, Pull Box of Proper Sizes and Dimensions shall be provided. Although not indicated in the Plan.

Provide Circuit Directory to be located inside the Panelboard for Circuit Identification.

Mounting Heights above Finish Floor Line

Switches	1.37m	Center
Panelboard	1.83m	Center
Kilowatt-Hour Meter	1.83m	Center
Convenience Outlet	0.30m	Bottom

All Electrical works herein must be done only under the direct supervision of a duly registered Electrical Engineer or Master Electrician.

**SCHEDULE OF LOADS**

CIRCUIT NO.	DESCRIPTION	QUANTITY	VOLTS	VOLT-AMP	AMPERE	CIRCUIT BREAKER	CONDUCTOR SIZE	CONDUIT SIZE
C1	LIGHTING OUTLET	6	230	600	2.61	20 A	2- 3.5mm <sup>2</sup> THHN Stranded Copper Wire	20mm dia. PVC
C2	CONVENIENCE OUTLET	4	230	720	3.13	20 A	2- 3.5mm <sup>2</sup> THHN Stranded Copper Wire	20mm dia. PVC
C3	SPARE	1	230	500	2.17	20 A		
	MAIN			1,820		40 A	2-8.0 mm <sup>2</sup> THW Stranded Copper Wire	25mm dia. RSC

**COMPUTATION**

$$I_L = \frac{\text{TOTAL VA} \times 85\% \text{ DEMAND FACTOR}}{230 \text{ V}}$$

$$I_L = \frac{1,820 \text{ VA} \times 85\%}{230 \text{ V}}$$

$$I_L = 6.73 \text{ A}$$

$$I_{ckt} = I_L (1.25)$$

$$I_{ckt} = 6.73 (1.25)$$

$$I_{ckt} = 8.41 \text{ A}$$

USE :

8.0 mm<sup>2</sup> THW Stranded Copper Wire  
inside 25mm Ø Rigid Steel Conduit Pipe.  
40 AT, 240V, 2P, 60 HZ as Main Circuit Breaker

**SINGLE LINE DIAGRAM**

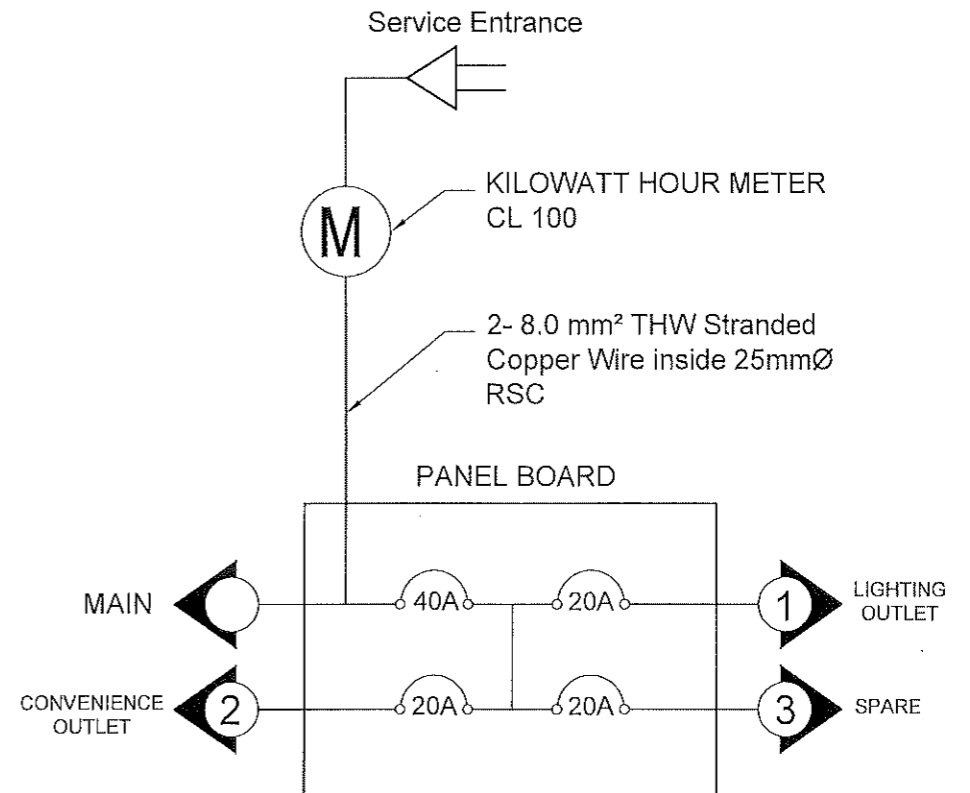

REPUBLIC OF THE PHILIPPINES  
**PROVINCIAL ENGINEER'S OFFICE**  
SAN AGUSTIN, DIGOS CITY, DAVAO DEL SUR

PROJECT TITLE:  
**CONSTRUCTION OF COVERED SPACE WITH STAGE**

LOCATION: SAN ISIDRO ELEMENTARY SCHOOL, SAN ISIDRO, MAGSAYSAY, DAVAO DEL SUR

PREPARED BY:  
*Christian Rodolfo Dumasig*  
**CHRISTIAN RODOLFO DUMASIG**  
ENGINEER I

REVIEWED BY:  
*Joseph R. Gonzales*  
**JOSEPH R. GONZALES**  
ENGINEER - III  
PLANNING AND PROGRAMMING DIV. HEAD

RECOMMENDING APPROVAL:  
*Angelie R. Gela*  
**ANGELIE R. GELA**  
PGADH - ASSISTANT PROVINCIAL ENGINEER  
OIC - PROVINCIAL ENGINEER  
(AS PER MEMO NO. 22 - 2023)

APPROVED BY:  
*Yvonne Rona Cagas*  
**YVONNE RONA CAGAS**  
PROVINCIAL GOVERNOR

SHEET NO.:  
**E-1**  
1113

# SUMMARY OF QUANTITIES

ITEM NO.	DESCRIPTION	QTY.	UNIT
<b>PART B OTHER GENERAL REQUIREMENTS</b>			
B.3	Permits and Clearances	1.00	l.s.
B.5	Project Billboard/ Signboard	1.00	each
B.7	Occupational Safety and Health	1.00	l.s.
<b>PART C EARTHWORK</b>			
803 (1)a	Structure Excavation (Common Soil)	15.16	cu.m.
804(1)b	Embankment from borrow	49.77	cu.m.
804 (4)	Gravel Fill	20.22	cu.m.
<b>PART D REINFORCED CONCRETE</b>			
900 (1)c	Structural Concrete ,Class A, 3000 psi, 28 days	21.84	cu.m.
902 (1)a1	Reinforcing Steel (Deformed) Grade 40	1,191.31	kg.
903 (2)	Formworks and Falseworks	59.31	sq.m.
<b>PART E FINISHINGS AND OTHER CIVIL WORKS</b>			
1046(2)a1	CHB Non Load Bearing (including Reinforcing Steel),100 mm	106.08	sq.m.
1027 (1)	Cement Plaster Finish	126.35	sq.m.
1001 (9)	Storm Drainage & Downspout	1.00	l.s.
1003(1)b2	Ceiling, 4.5mm, Wood Frame, Marine Plywood	161.50	sq.m.
1003(17)	Carpentry and Joinery Works	1.00	l.s.
1013(2)a1	Fabricated Metal Roofing Accessory, Gauge 26 (0.551mm), Ridge/Hip Rolls	17.00	ln.m
1013(2)a2	Fabricated Metal Roofing Accessory, Gauge 26 (0.701mm), Flashing	20.68	ln.m
1013(2)b1	Fabricated Metal Roofing Accessory, Gauge 26 (0.701mm), Gutters	34.00	ln.m
1014(1)b2	Pre-painted Metal Sheets, above 0.427mm., Rib Type, Long Span	175.78	sq.m.
1047(1)	Structural Steel	1.00	l.s.
1047(8)	Structural Steel, Roof Framing	1.00	l.s.
1032(1)a	Painting Works, Masonry/Concrete	126.35	sq.m.
1032(1)b	Painting Works, Wood	161.50	sq.m.
<b>PART F ELECTRICALS</b>			
1100 (10)	Conduits, Boxes & Fittings (Conduit Works/Conduit Rough-In)	1.00	l.s.
1101(33)	Wires and Wiring Devices	1.00	l.s.
1102 (1)	Panelboard with Main & Branch Breakers	1.00	l.s.
1103 (1)	Lighting Fixtures	1.00	l.s.



REPUBLIC OF THE PHILIPPINES  
**PROVINCIAL ENGINEER'S OFFICE**  
SAN AGUSTIN, DIGOS CITY, DAVAO DEL SUR

PROJECT TITLE:  
**CONSTRUCTION OF COVERED SPACE WITH STAGE**

LOCATION: **SAN ISIDRO ELEMENTARY SCHOOL, SAN ISIDRO, MAGSAYSAY, DAVAO DEL SUR**

PREPARED BY:  
  
**FRANKLIN N. ISLA III**  
ENGINEERING ASSISTANT

REVIEWED BY:  
  
**JOSEPH R. GONZALES**  
ENGINEER - III  
PLANNING AND PROGRAMMING DIV. HEAD

RECOMMENDING APPROVAL:  
  
**ANGELIE R. GELLA**  
PGADH - ASSISTANT PROVINCIAL ENGINEER  
OIC - PROVINCIAL ENGINEER  
(AS PER MEMO NO. 22 - 2023)

APPROVED BY:  
  
**YVONNE RON CAGAS**  
PROVINCIAL GOVERNOR

SHEET NO.:  
0-2  
1313

# **SECTION VIII.**

## **BILL OF QUANTITIES**

[See attached file.]



**BILL OF QUANTITIES**

Contract Name : **CONSTRUCTION OF COVERED SPACE WITH STAGE**  
 Location of the Contract : **SAN ISIDRO ELEMENTARY SCHOOL, SAN ISIDRO, MAGSAYSAY, DAVAO DEL SUR**  
 Project Duration : **75 CALENDAR DAYS**

**SUMMARY OF BID PRICES**  
**(All Parts of Bill of Quantities)**

1. Part No. - Enter the "Part No." for each section of the Bill of Quantities (BOQ) where unit prices are entered.
2. Part Description - Enter the "Part Description" corresponding to the "Part No."
3. Total Amount - Enter the "total amount" in Pesos for all pages having the same "Part Description".
4. Adopting Green Procurement Policy by SBAC Resolution No. 140 series of 2019.

Contract ID:	Part Description	Total Amount
B.3	Permits and Clearances	P
B.5	Project Billboard/ Signboard	P
B.7	Occupational Safety and Health	P
803 (1)a	Structure Excavation (Common Soil)	P
804(1)b	Embankment from borrow	P
804 (4)	Gravel Fill	P
900 (1)c	Structural Concrete ,Class A, 3000 psi, 28 days	P
902 (1)a1	Reinforcing Steel (Deformed) Grade 40	P
903 (2)	Formworks and Falseworks	P
1046(2)a1	CHB Non Load Bearing (including Reinforcing Steel),100 mm	P
1027 (1)	Cement Plaster Finish	P
1001 (9)	Storm Drainage & Downspout	P
1003(1)b2	Ceiling, 4.5mm, Wood Frame, Marine Plywood	P
1003(17)	Carpentry and Joinery Works	P
1013(2)a1	Fabricated Metal Roofing Accessory, Gauge 26 (0.551mm), Ridge/Hip Rolls	P
1013(2)a2	Fabricated Metal Roofing Accessory, Gauge 26 (0.701mm), Flashing	P
1013(2)b1	Fabricated Metal Roofing Accessory, Gauge 26 (0.701mm), Gutters	P
1014(1)b2	Pre-painted Metal Sheets, above 0.427mm., Rib Type, Long Span	P
1047(1)	Structural Steel	P
1047(8)	Structural Steel, Roof Framing	P
1032(1)a	Painting Works, Masonry/Concrete	P
1032(1)b	Painting Works, Wood	P
1100 (10)	Conduits, Boxes & Fittings (Conduit Works/Conduit Rough-In)	P
1101(33)	Wires and Wiring Devices	P
1102 (1)	Panelboard with Main & Branch Breakers	P
1103 (1)	Lighting Fixtures	P
<b>Total of All Amounts</b>		<b>P</b>
Total of All Amounts in Words: PESOS _____ and _____ centavos		

Name : \_\_\_\_\_ In capacity of \_\_\_\_\_  
 Signed : \_\_\_\_\_ Date \_\_\_\_\_

Duly authorized to sign the Bid for and on behalf of \_\_\_\_\_

Contract Name

: CONSTRUCTION OF COVERED SPACE WITH STAGE

Location of the Contract

: SAN ISIDRO ELEMENTARY SCHOOL, SAN ISIDRO, MAGSAYSAY, DAVAO DEL SUR

Project Duration

: 75 CALENDAR DAYS

**BILL OF QUANTITIES**

Part No. \_\_\_\_\_

Pay Item No.	Description	Unit	Quantity	Unit Price (Pesos)	Amount (Pesos)
1	2	3	4	5	6
B.3	Permits and Clearances	l.s.	1.00		In words: _____ In figures: _____
B.5	Project Billboard/ Signboard	each	1.00		In words: _____ In figures: _____
B.7	Occupational Safety and Health	l.s.	1.00		In words: _____ In figures: _____
803 (1)a	Structure Excavation (Common Soil)	cu.m.	15.16		In words: _____ In figures: _____
804(1)b	Embankment from borrow	cu.m.	49.77		In words: _____ In figures: _____
804 (4)	Gravel Fill	cu.m.	20.22		In words: _____ In figures: _____

Submitted by: \_\_\_\_\_

Name of the Representative of the Bidder

Date

Position

Name of Bidder

Contract Name

: CONSTRUCTION OF COVERED SPACE WITH STAGE

Location of the Contract

: SAN ISIDRO ELEMENTARY SCHOOL, SAN ISIDRO, MAGSAYSAY, DAVAO DEL SUR

Project Duration

: 75 CALENDAR DAYS

### BILL OF QUANTITIES

Part No. \_\_\_\_\_

Pay Item No.	Description	Unit	Quantity	Unit Price (Pesos)	Amount (Pesos)
1					
900 (1)c	Structural Concrete ,Class A, 3000 psi, 28 days	cu.m.	21.84		In words: _____ In figures: _____
902 (1)a1	Reinforcing Steel (Deformed) Grade 40	kg.	1,191.31		In words: _____ In figures: _____
903 (2)	Formworks and Falseworks	sq.m.	59.31		In words: _____ In figures: _____
1046(2)a1	CHB Non Load Bearing (including Reinforcing Steel),100 mm	sq.m.	106.08		In words: _____ In figures: _____
1027 (1)	Cement Plaster Finish	sq.m.	126.35		In words: _____ In figures: _____
1001 (9)	Storm Drainage & Downspout	l.s.	1.00		In words: _____ In figures: _____

Submitted by: \_\_\_\_\_

Name of the Representative of the Bidder \_\_\_\_\_

Date : \_\_\_\_\_

Position \_\_\_\_\_

Name of Bidder \_\_\_\_\_

Contract Name

: CONSTRUCTION OF COVERED SPACE WITH STAGE

Location of the Contract

: SAN ISIDRO ELEMENTARY SCHOOL, SAN ISIDRO, MAGSAYSAY, DAVAO DEL SUR

Project Duration

: 75 CALENDAR DAYS

**BILL OF QUANTITIES**

Part No. \_\_\_\_\_

Pay Item No.	Description	Unit	Quantity	Unit Price (Pesos)	Amount (Pesos)
1	2	3	4	5	6
1003(1)b2	Ceiling, 4.5mm, Wood Frame, Marine Plywood	sq.m.	161.50	In words: _____ In figures: _____	In words: _____ In figures: _____
1003(17)	Carpentry and Joinery Works	l.s.	1.00	In words: _____ In figures: _____	In words: _____ In figures: _____
1013(2)a1	Fabricated Metal Roofing Accessory, Gauge 26 (0.551mm), Ridge/Hip Rolls	In.m	17.00	In words: _____ In figures: _____	In words: _____ In figures: _____
1013(2)a2	Fabricated Metal Roofing Accessory, Gauge 26 (0.701mm), Flashing	In.m	20.68	In words: _____ In figures: _____	In words: _____ In figures: _____
1013(2)b1	Fabricated Metal Roofing Accessory, Gauge 26 (0.701mm), Gutters	In.m	34.00	In words: _____ In figures: _____	In words: _____ In figures: _____
1014(1)b2	Pre-painted Metal Sheets, above 0.427mm., Rib Type, Long Span	sq.m.	175.78	In words: _____ In figures: _____	In words: _____ In figures: _____

Submitted by: \_\_\_\_\_

Name of the Representative of the Bidder \_\_\_\_\_

Date : \_\_\_\_\_

Position \_\_\_\_\_

Name of Bidder \_\_\_\_\_

Contract Name : CONSTRUCTION OF COVERED SPACE WITH STAGE

Location of the Contract : SAN ISIDRO ELEMENTARY SCHOOL, SAN ISIDRO, MAGSAYSAY, DAVAO DEL SUR  
 Project Duration : 75 CALENDAR DAYS

**BILL OF QUANTITIES**

Part No. \_\_\_\_\_

Pay Item No.	Description	Unit	Quantity	Unit Price (Pesos)	Amount (Pesos)
1	2	3	4	5	6
1047(1)	Structural Steel	l.s.	1.00	In words: _____ In figures: _____	In words: _____ In figures: _____
1047(8)	Structural Steel, Roof Framing	l.s.	1.00	In words: _____ In figures: _____	In words: _____ In figures: _____
1052(1)a	Painting Works, Masonry/Concrete	sq.m.	126.35	In words: _____ In figures: _____	In words: _____ In figures: _____
1052(1)b	Painting Works, Wood	sq.m.	161.50	In words: _____ In figures: _____	In words: _____ In figures: _____
1100 (10)	Conduits, Boxes & Fittings (Conduit Works/Conduit Rough-in)	l.s.	1.00	In words: _____ In figures: _____	In words: _____ In figures: _____
1101(33)	Wires and Wiring Devices	l.s.	1.00	In words: _____ In figures: _____	In words: _____ In figures: _____

Submitted by: \_\_\_\_\_

Name of the Representative of the Bidder \_\_\_\_\_

Date : \_\_\_\_\_

Position \_\_\_\_\_

Name of Bidder \_\_\_\_\_

Contract Name

: CONSTRUCTION OF COVERED SPACE WITH STAGE

Location of the Contract

: SAN ISIDRO ELEMENTARY SCHOOL, SAN ISIDRO, MAGSAYSAY, DAVAO DEL SUR

Project Duration

: 75 CALENDAR DAYS

### BILL OF QUANTITIES

Part No. \_\_\_\_\_

Pay Item No.	Description	Unit	Quantity	Unit Price (Pesos)	Amount (Pesos)
				5	6
1102 (1)	Panelboard with Main & Branch Breakers	1s.	1.00	In words: _____ In figures: _____	In words: _____ In figures: _____
1103 (1)	Lighting Fixtures	1.s.	1.00	In words: _____ In figures: _____	In words: _____ In figures: _____

Submitted by: \_\_\_\_\_

Name of the Representative of the Bidder \_\_\_\_\_

Date : \_\_\_\_\_

Position \_\_\_\_\_

## **SECTION IX.**

# **CHECKLIST OF TECHNICAL AND FINANCIAL DOCUMENTS**

# PROCUREMENT MANAGEMENT OFFICE

## BIDS AND AWARDS COMMITTEE

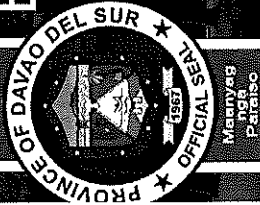

Mobile Nos. 0905-229-0526/0908-332-2024 (Goods), 0948-768-5848 (Infra)  
Telefax: (082) 553-9579

Website: [www.davaodelsur.gov.ph/pgc-bac](http://www.davaodelsur.gov.ph/pgc-bac)

Email Add.: [bac.davaodelsur2@gmail.com](mailto:bac.davaodelsur2@gmail.com)/[sbacdavaodelsur@gmail.com](mailto:sbacdavaodelsur@gmail.com)

*Davao del Sur*

### CHECKLIST-CIVIL

IB No:

Opening of Bids:

Name of Project/Brief Description of Goods:			
PR:	Dated:	ABC	End User:
Name of Contractor/Supplier:			
Address:			
Contact Number:			
<b>ENVELOPE 1- ELIGIBILITY DOCUMENTS/TECHNICAL</b>			
1. Class "A" Documents			
Legal Documents			
a. Valid PhilGEPS Registration Certificate (Platinum Membership) with its corresponding Annex A.			
Technical Documents			
b. Statement of the prospective bidder of all its on-going government and private contracts, including contracts awarded but not yet started (7 calendar days before the bid opening), if any, whether similar or not similar in nature and complexity to the contract to be bid with supporting documents such as Notice of Award and/or Contract, Notice to Proceed, and Certificate of Accomplishment or Statement of Time Elapsed and Work Accomplished.			
c. Statement of the bidder's Single Largest Completed Contract (SLCC) similar to the contract to be bid for the last (3) years, and whose value, adjusted to current prices using the PSA consumer price indices, must be at least fifty percent (50%) of the ABC to be bid: Provided, however, that contractors under Small A and Small B categories without similar experience on the contract to be bid may be allowed to bid if the cost of such contract is not more than the Allowable Range of Contract Cost (ARCC) of their registration based on the guidelines as prescribed by the PCAB. This Statement must be supported with the following: Contract/ Purchase Order, Certificate of Completion/ Acceptance or Inspection Report or Official Receipt, Validated Contractors/Constructors Performance Evaluation System (CPES) in DPWH website.			
d. Valid Philippine Contractors Accreditation Board (PCAB) License or Special PCAB License in case of Joint Ventures, and Registration for the type and cost of the contract to be bid.			
Financial Documents			
e. The prospective bidder's computation of Net Financial Contracting Capacity (NFCC). However, in the case of procurement of Goods, a bidder may submit a committed Line of Credit from a Universal or Commercial Bank, in lieu of its NFCC computation. (Note: K=15)			
2. Class "B" Documents			
a. For Infrastructure Projects, Joint Venture bidders shall submit a Joint Venture Agreement in accordance with R.A. 4566 and its IRR. Each partner of the joint venture shall submit their respective PhilGEPS Certificates of Registration in accordance with Section 8.5.2 of this IRR. The submission of technical and financial eligibility documents by any of the joint venture partners constitutes compliance: Provided, that the partner responsible to submit the NFCC shall likewise submit the Statement of all of its ongoing contracts and Audited Statements.			
<b>TECHNICAL PROPOSAL</b>			
1. Original copy of Bid Security in the form of the following: <ul style="list-style-type: none"> <li><input type="checkbox"/> Cash or Cashier's/ Manager's check (2%)</li> <li><input type="checkbox"/> Bank Guarantee/ Draft or Irrevocable Letter of Credit (2%)</li> <li><input type="checkbox"/> Surety Bond callable upon demand (5%)</li> <li><input type="checkbox"/> Bid Securing Declaration (in the prescribed form)</li> </ul>			
2. Project Requirements, which shall include the following: <ul style="list-style-type: none"> <li>a. Organizational chart for the contract to be bid</li> <li>b. List of contractor's personnel (viz., Project Manager, Project Engineers, Materials Engineers, and Foremen), to be assigned to the contract to be bid, with their complete qualifications and experience data.</li> </ul>			



	<p>c. List of contractor's equipment units, which are owned, leased, and/or under purchase agreements, supported by certification of availability of equipment from the equipment lessor/vendor for the duration of the project;</p>
	<p>3. Original Duly Signed Omnibus Sworn Statement (OSS) by the prospective bidder or its duly authorized representative; and if applicable, Original Notarized Secretary's Certificate in case of a corporation, partnership, or cooperative; or Original Special Power of Attorney of all members of the joint venture giving full power and authority to its officer to sign the OSS and do acts to represent the bidder.</p>
	<p>4. Other documents/materials to comply with other non-discretionary criteria and requirements as stated in the Instruction to Bidders:</p> <ul style="list-style-type: none"> <li>• Construction Methods</li> <li>• Construction schedule and S-Curve</li> <li>• Pert-CPM</li> <li>• Manpower Utilization</li> <li>• Equipment Utilization</li> <li>• Construction Safety &amp; Health Program</li> <li>• Duly Notarized Affidavit of Site Inspection</li> <li>• Duly Notarized Certification as to Compliance to Labor Laws and Standard</li> </ul>
	<p>QUALIFIED</p>
	<p>DISQUALIFIED</p>
<p><b>ENVELOPE 2- FINANCIAL PROPOSAL</b></p>	
	<p>1. Duly Signed Financial Bid Form</p>
	<p>2. Duly Signed Bid Prices in the Bill of Quantities</p>
	<p>3. Duly Signed Detailed Estimates</p>
	<p>4. Duly Signed Cash Flow by Quarter and Payment Schedules</p>

# **SECTION X.**

## **OTHER DOCUMENTS**

- 1) Purchase Request
- 2) Statement of all On-going Government & Private Contracts including  
Contracts awarded but not yet started (Prescribed Form)
- 3) Statement of Single Largest Completed Contract (Prescribed Form)
- 4) Bid Securing Declaration (Prescribed Form)
- 5) Omnibus Sworn Statement (Prescribed Form)
- 6) Bid Form Prescribed Form)
- 7) Resolution No. 001 Series of 2018 / Three-Strike Policy
- 8) Resolution No. 007 Series of 2022
- 9) TWG – Checklist for Bid Evaluation
- 10) TWG – Checklist for Post Qualification

# PURCHASE REQUEST

## PROVINCE OF DAVAO DEL SUR

MATTI, DIGOS CITY

Department : PROVINCIAL ENGINEER'S OFFICE PR NO. : 061-25-5 Date : 05/11/23  
 Section : Construction SAI NO. : \_\_\_\_\_ Date : \_\_\_\_\_

STOCK No.	UNIT OF ISSUE	ITEM DESCRIPTION	QTY	UNIT COST	TOTAL COST
1	Job Order	<p><b>CONSTRUCTION OF COVERED SPACE WITH STAGE</b> located at <b>SAN ISIDRO ELEMENTARY SCHOOL, SAN ISIDRO, MAGSAYSAY, DAVAO DEL SUR</b> all in accordance to plans, specifications and scope of work and the Green Procurement Policy as adopted by Executive Order No. 30 series of 2019.</p> <p style="text-align: center;">XXXXXXXXXXXXXXXXX</p> <p style="text-align: center;">TOTAL</p>	1	P 1,300,000.00 VVVVVVVV	
		<p><b>TECHNICAL WORKING GROUP</b>                      TECHNICAL SPECS CONTROLLED                      BY: <i>[Signature]</i>                      DATE: <i>[Date]</i></p>			
		<p>Charge to:                      Construction of Covered Space with Stage                      San Isidro Elementary School, San Isidro, Magsaysay, Davao del Sur                      CY 2023 ANNUAL SPECIAL EDUCATION FUND (SEF) BUDGET</p>			

Purpose/Remarks For use in the **CONSTRUCTION OF COVERED SPACE WITH STAGE** located at **SAN ISIDRO ELEMENTARY SCHOOL, SAN ISIDRO, MAGSAYSAY, , DAVAO DEL SUR**

APPROVED NO. 118-2023-01200

*[Signature]*  
**YVONNE ROÑA CAGAS**  
 Governor

Signature : <i>[Signature]</i>	CASH AVAILABILITY : <i>[Signature]</i>	APPROVED :
Printed Name : <b>ANGÉLIE R. GELLA</b>	<b>FARAH GEMMA V. BIDAN, CPA</b>	<b>YVONNE ROÑA CAGAS</b>
Designation : <b>OIC-Provincial Engineer</b>	<i>Provincial Treasurer</i>	<i>Governor</i>
Date : <b>April 25, 2023</b>	<b>988</b>	<i>[Signature]</i>

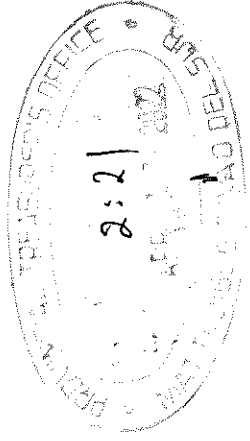

## Statement of all On-going Government & Private Contracts including Contracts awarded but not yet started

Name of Project / Contact : \_\_\_\_\_

IB No. \_\_\_\_\_

Location: \_\_\_\_\_

Name of Contract / Location	a)Owner's Name b)Address c)Telephone No.	Nature of Work	Bidder's Role		a) Amount at award b) Duration	a)Date Awarded b)Date Started c)Target Completion Date	% of Accomplishment		Value of Outstanding Works/Undelivered Portion
			Description	%			Planned	Actual	
Government									
Private									
<b>Total Cost</b>									<b>P</b>

Note: This Statement shall be supported with:

1. Notice of Award and/or Contract
2. Notice to Proceed issued by the Procuring Entity
3. Certificate of Accomplishments signed by the owner or authorized representative

Submitted by : \_\_\_\_\_  
(Printed Name & Signature)

Designation : \_\_\_\_\_

Date : \_\_\_\_\_

**Statement of Single Largest Completed Contract (SLCC)**

(in Nature for the Last 3 years)

Name of Project/Contract: \_\_\_\_\_

IB No. \_\_\_\_\_

Location: \_\_\_\_\_

Name of Contract / Description Project Cost	a)Owner's Name b)Address c)Telephone No.	Nature of Work	Bidder's Role		a) Amount at Award b) Amount at Completion c) Duration	a) Date Awarded b) Date Started c) Date of Completion
			Description	%		

This statement shall be supported with:

1. Contract/Purchase Order
2. Certificate of Completion/Acceptance or Inspection and Acceptance Report or Official Receipts

Prepared by: \_\_\_\_\_

(Printed Name & Signature)

Position: \_\_\_\_\_

\_\_\_\_\_

## **Bid Securing Declaration Form**

*[shall be submitted with the Bid if bidder opts to provide this form of bid security]*

---

REPUBLIC OF THE PHILIPPINES)  
CITY OF \_\_\_\_\_ ) S.S.

**BID SECURING DECLARATION**  
Project Identification No.: *[Insert number]*

To: *[Insert name and address of the Procuring Entity]*

I/We, the undersigned, declare that:

1. I/We understand that, according to your conditions, bids must be supported by a Bid Security, which may be in the form of a Bid Securing Declaration.
2. I/We accept that: (a) I/we will be automatically disqualified from bidding for any procurement contract with any procuring entity for a period of two (2) years upon receipt of your Blacklisting Order; and, (b) I/we will pay the applicable fine provided under Section 6 of the Guidelines on the Use of Bid Securing Declaration, within fifteen (15) days from receipt of the written demand by the procuring entity for the commission of acts resulting to the enforcement of the bid securing declaration under Sections 23.1(b), 34.2, 40.1 and 69.1, except 69.1(f), of the IRR of RA No. 9184; without prejudice to other legal action the government may undertake.
3. I/We understand that this Bid Securing Declaration shall cease to be valid on the following circumstances:
  - a. Upon expiration of the bid validity period, or any extension thereof pursuant to your request;
  - b. I am/we are declared ineligible or post-disqualified upon receipt of your notice to such effect, and (i) I/we failed to timely file a request for reconsideration or (ii) I/we filed a waiver to avail of said right; and
  - c. I am/we are declared the bidder with the Lowest Calculated Responsive Bid, and I/we have furnished the performance security and signed the Contract.

IN WITNESS WHEREOF, I/We have hereunto set my/our hand/s this \_\_\_\_ day of *[month]* *[year]* at *[place of execution]*.

*[Insert NAME OF BIDDER OR ITS AUTHORIZED  
REPRESENTATIVE]*

*[Insert signatory's legal capacity]*  
Affiant

**[Jurat]**

*[Format shall be based on the latest Rules on Notarial Practice]*

## Omnibus Sworn Statement (Revised)

*[shall be submitted with the Bid]*

REPUBLIC OF THE PHILIPPINES )  
CITY/MUNICIPALITY OF \_\_\_\_\_ ) S.S.

### AFFIDAVIT

I, [Name of Affiant], of legal age, [Civil Status], [Nationality], and residing at [Address of Affiant], after having been duly sworn in accordance with law, do hereby depose and state that:

1. *[Select one, delete the other:]*

*[If a sole proprietorship:]* I am the sole proprietor or authorized representative of [Name of Bidder] with office address at [address of Bidder];

*[If a partnership, corporation, cooperative, or joint venture:]* I am the duly authorized and designated representative of [Name of Bidder] with office address at [address of Bidder];

2. *[Select one, delete the other:]*

*[If a sole proprietorship:]* As the owner and sole proprietor, or authorized representative of [Name of Bidder], I have full power and authority to do, execute and perform any and all acts necessary to participate, submit the bid, and to sign and execute the ensuing contract for [Name of the Project] of the [Name of the Procuring Entity], as shown in the attached duly notarized Special Power of Attorney;

*[If a partnership, corporation, cooperative, or joint venture:]* I am granted full power and authority to do, execute and perform any and all acts necessary to participate, submit the bid, and to sign and execute the ensuing contract for [Name of the Project] of the [Name of the Procuring Entity], as shown in the attached [state title of attached document showing proof of authorization (e.g., duly notarized Secretary's Certificate, Board/Partnership Resolution, or Special Power of Attorney, whichever is applicable)];

3. [Name of Bidder] is not "blacklisted" or barred from bidding by the Government of the Philippines or any of its agencies, offices, corporations, or Local Government Units, foreign government/foreign or international financing institution whose blacklisting rules have been recognized by the Government Procurement Policy Board, by itself or by relation, membership, association, affiliation, or controlling interest with another blacklisted person or entity as defined and provided for in the Uniform Guidelines on Blacklisting;

4. Each of the documents submitted in satisfaction of the bidding requirements is an authentic copy of the original, complete, and all statements and information provided therein are true and correct;

5. [Name of Bidder] is authorizing the Head of the Procuring Entity or its duly authorized representative(s) to verify all the documents submitted;

6. *[Select one, delete the rest:]*

*[If a sole proprietorship:]* The owner or sole proprietor is not related to the Head of the Procuring Entity, members of the Bids and Awards Committee (BAC), the Technical

Working Group, and the BAC Secretariat, the head of the Project Management Office or the end-user unit, and the project consultants by consanguinity or affinity up to the third civil degree;

*[If a partnership or cooperative:]* None of the officers and members of *[Name of Bidder]* is related to the Head of the Procuring Entity, members of the Bids and Awards Committee (BAC), the Technical Working Group, and the BAC Secretariat, the head of the Project Management Office or the end-user unit, and the project consultants by consanguinity or affinity up to the third civil degree;

*[If a corporation or joint venture:]* None of the officers, directors, and controlling stockholders of *[Name of Bidder]* is related to the Head of the Procuring Entity, members of the Bids and Awards Committee (BAC), the Technical Working Group, and the BAC Secretariat, the head of the Project Management Office or the end-user unit, and the project consultants by consanguinity or affinity up to the third civil degree;

7. *[Name of Bidder]* complies with existing labor laws and standards; and
8. *[Name of Bidder]* is aware of and has undertaken the responsibilities as a Bidder in compliance with the Philippine Bidding Documents, which includes:
  - a. Carefully examining all of the Bidding Documents;
  - b. Acknowledging all conditions, local or otherwise, affecting the implementation of the Contract;
  - c. Making an estimate of the facilities available and needed for the contract to be bid, if any; and
  - d. Inquiring or securing Supplemental/Bid Bulletin(s) issued for the *[Name of the Project]*.
9. *[Name of Bidder]* did not give or pay directly or indirectly, any commission, amount, fee, or any form of consideration, pecuniary or otherwise, to any person or official, personnel or representative of the government in relation to any procurement project or activity.
10. In case advance payment was made or given, failure to perform or deliver any of the obligations and undertakings in the contract shall be sufficient grounds to constitute criminal liability for Swindling (Estafa) or the commission of fraud with unfaithfulness or abuse of confidence through misappropriating or converting any payment received by a person or entity under an obligation involving the duty to deliver certain goods or services, to the prejudice of the public and the government of the Philippines pursuant to Article 315 of Act No. 3815 s. 1930, as amended, or the Revised Penal Code.

IN WITNESS WHEREOF, I have hereunto set my hand this \_\_\_ day of \_\_\_, 20\_\_ at \_\_\_\_\_, Philippines.

*[Insert NAME OF BIDDER OR ITS AUTHORIZED REPRESENTATIVE]*  
*[Insert signatory's legal capacity]*  
Affiant

***[Jurat]***  
*[Format shall be based on the latest Rules on Notarial Practice]*



**Bid Form for the Procurement of Infrastructure Projects**  
*[shall be submitted with the Bid]*

---

**BID FORM**

Project Identification No. : \_\_\_\_\_

Date : \_\_\_\_\_

To: *[name and address of Procuring Entity]*

Having examined the Philippine Bidding Documents (PBDs) including the Supplemental or Bid Bulletin Numbers *[insert numbers]*, the receipt of which is hereby duly acknowledged, we, the undersigned, declare that:

- a. We have no reservation to the PBDs, including the Supplemental or Bid Bulletins, for the Procurement Project: *[insert name of contract]*;
- b. We offer to execute the Works for this Contract in accordance with the PBDs;
- c. The total price of our Bid in words and figures, excluding any discounts offered below is: *[insert information]*;
- d. The discounts offered and the methodology for their application are: *[insert information]*;
- e. The total bid price includes the cost of all taxes, such as, but not limited to: *[specify the applicable taxes, e.g. (i) value added tax (VAT), (ii) income tax, (iii) local taxes, and (iv) other fiscal levies and duties]*, which are itemized herein and reflected in the detailed estimates.
- f. Our Bid shall be valid within the a period stated in the PBDs, and it shall remain binding upon us at any time before the expiration of that period;
- g. If our Bid is accepted, we commit to obtain a Performance Security in the amount of *[insert percentage amount]* percent of the Contract Price for the due performance of the Contract, or a Performance Securing Declaration in lieu of the allowable forms of Performance Security, subject to the terms and conditions of issued GPPB guidelines<sup>1</sup> for this purpose;
- h. We are not participating, as Bidders, in more than one Bid in this bidding process, other than alternative offers in accordance with the Bidding Documents;
- i. We understand that this Bid, together with your written acceptance thereof included in your notification of award, shall constitute a binding contract between us, until a formal Contract is prepared and executed; and
- j. We understand that you are not bound to accept the Lowest Calculated Bid or any other Bid that you may receive.
- k. We likewise certify/confirm that the undersigned, is the duly authorized

---

<sup>1</sup> currently based on GPPB Resolution No. 09-2020

representative of the bidder, and granted full power and authority to do, execute and perform any and all acts necessary to participate, submit the bid, and to sign and execute the ensuing contract for the [Name of Project] of the [Name of the Procuring Entity].

- I. We acknowledge that failure to sign each and every page of this Bid Form, including the Bill of Quantities, shall be a ground for the rejection of our bid.

Name: \_\_\_\_\_

Legal Capacity: \_\_\_\_\_

Signature: \_\_\_\_\_

Duly authorized to sign the Bid for and behalf of: \_\_\_\_\_

Date: \_\_\_\_\_



Republic of the Philippines  
**PROVINCE OF DAVAO DEL SUR**  
 Barangay Matti, Digos City

**OFFICE OF THE SPECIAL BIDS AND AWARDS COMMITTEE (SBAC)**

**Resolution NO. 001**  
 Series of 2018

**A RESOLUTION**

**RECOMMENDING TO THE HEAD OF THE PROCURING ENTITY, GOVERNOR DOUGLAS R. CAGAS, LLB, MBE, MNSA TO ADOPT THE 3-STRIKE POLICY IN THE PROCUREMENT OF CONTRACS FOR INFRASTRUCTURE WORKS OF THE PROVINCIAL GOVERNMENT OF DAVAO DEL SUR.**

*WHEREAS*, the Provincial Government of Davao del Sur encounters several failures of biddings due to constant errors committed by the participating Bidders in the submission of their bidding documents despite of the orientation during Pre-bid Conference and the Instruction to Bidders;

*WHEREAS*, to further strengthen the integrity of the competitive bidding process, the Special Bids and Awards Committee together with the Members of the Technical Working Group Unanimously agreed that the following instructions are hereby issued pertaining to the implementation of the 3-Strike Policy of the Provincial Government of Davao del Sur against violations of Section 69 of the IRR of RA 9184;

1. The provision of Section 69.1 of the said IRR, pertaining to 3-Strike policy of the Provincial Government of Davao del Sur, is hereby reiterated as follows:

*“The addition to the provision of Rules XXI and XXII of this IRR, the Head of the Procuring Entity subject to the authority delegated to the SBAC, if any, shall impose on bidders or prospective bidders, the administrative penalty of suspension for one (1) year for the first offense, and suspension of two(2) years for the second offense from participating in the competitive bidding process, as well as disqualification from further participating in the competitive bidding being undertaken by the Procuring Entity concerned, where applicable, for the following violations: 69.1.1 All other acts that tend to defeat the purpose of competitive bidding, such as habitually withdrawing from bidding, submitting late bids or patently insufficient bid, for at least three (3) times within a year, except for valid reasons.”*

2. The violations enumerated, which are considered as acts that tend to defeat the purpose of competitive bidding under the 3-Strike policy, are hereby clarified to read as follows:
  - 2.a A Bidder that had purchased bidding documents, but subsequently (a) withdrawn from the bidding or (b) submitted a letter of non-participation, or (c) did not submit a bid – without a valid cause, as determined by the Special Bids and Awards Committee (SBAC).
  - 2.b Submission of erroneous, insufficient, defective documents such as, but not limited to, insufficient bid securities, any computational/typographical error in the submitted bidding documents and other deficiencies which causes bid disqualification;
  - 2.c Non-submission of post-qualification and other requirements within the prescribed period as specified in the notice issued by the SBAC;

*[Handwritten signatures and initials]*

**1. 2018 DAVAO DEL SUR**

NESTOR GERMANE  
 SAH VITACIANO DT YRADE  
 5/28/18

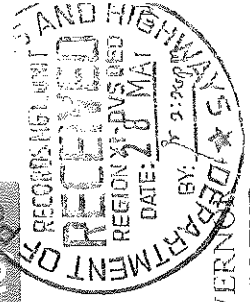



**OFFICE OF THE SPECIAL BIDS AND AWARDS COMMITTEE (SBAC)**

3. Each "offense" by a bidder referred to in Section 69.1.i of the IRR, as stated in the said Resolution no. 001 dated April 24, 2018, consists of three violations or strikes within a period of one year starting from the date of the first strike, for all procurements by all offices of the Provincial Government of Davao del Sur;
4. Every time a bidder is observed to have done any of the three acts enumerated in Item 2 of par. a b & c of this Resolution No. 001 dated April 24, 2018, the Chairperson of the SBAC shall immediately serve a written notice to the bidder informing him of his act, and giving him five (5) days to show cause why he should not be sanctioned committing an act which tends to defeat the purpose of public bidding under the 3-Strike policy of the Provincial Government of Davao del Sur;
5. Based on the evaluation by the SBAC of the bidder's response to the show-cause notice mentioned in Item No. 4 of this Resolution, the SBAC shall, within seven (7) days from receipt of the bidder's response determine whether the bidder's act was done with or without a valid cause.
6. The SBAC Secretariat shall submit to the SBAC a 3-Strike Policy Report, which shall contain the information in item 3 and 4 of this Resolution. The Report must be received by the SBAC through its Chairperson within fifteen (15) days after the date of opening of the bids;
7. The SBAC through its Secretariat shall monitor the participation of bidders in all of its projects and maintain a tally of violations by each bidder of the 3-Strike policy in its jurisdiction as well as of the violations by the bidder of the said policy in other offices of the Provincial Government of Davao del Sur.
8. Based on the 3-Strike reports, the Special Bids and Awards Committee, shall recommend to the Head of the Procuring Entity, for approval, the following administrative sanctions on the curing contractor/Supplier for the violation of the 3-Strike policy:
  - a. For the first violation or strike – a first warning.
  - b. For the second strike – a second warning.
  - c. For the third strike, which together with the first two strikes constitutes the first offense against the 3- strike policy – an administrative penalty of suspension for one (1) year from participating in any procurement process in the Provincial Government of Davao del Sur.
  - d. For the second offense- the second set of three strikes committed by the bidder- an administrative penalty of suspension for two (2) years from participating in any procurement process in the Provincial Government of Davao del Sur.

*WHEREFORE*, on motion of SBAC Member, Engr. Roderick R. Milana, duly seconded by all the SBAC Members present, it was –

*RESOLVED*, as it is hereby *RESOLVED*, to recommend to the Head of the Procuring Entity, DOUGLAS RA. CAGAS, LLB, MBE, MNSA to *ADOPT* the *3-Strike Policy in the Procurement of Contracts for Infrastructure Works of the Provincial Government of Davao del Sur*.

*RESOLVED FINALLY*, to furnish copies of this Resolution to the Provincial General Services Office, Commission on Audit, Concerned End Users, and Various Suppliers/Bidders, for their information and appropriate action;

**1 LOVE DAVAO DELSUR**



**OFFICE OF THE SPECIAL BIDS AND AWARDS COMMITTEE (SBAC)**

SBAC RESOLUTION NO. 001, S. 2018

Page -3-

X-X-X-X-X-X-X-X-X-X

**UNANIMOUSLY APPROVED** at the Provincial Planning and Development Office, Conference Room, Room 13, Executive Building, Capitol Compound, Matti, Digos City, Province of Davao del Sur, this 24<sup>th</sup> day of April, 2018.

I hereby certify the correctness of above-mentioned resolution.

  
**GYPSY JENISSEN C. ARQUIO**  
LAOOI  
Head, SBAC Secretariat

Attested by:

  
**GERALDINE S. LANO**  
PGDH-Provincial Social Welfare Officer  
SBAC Member

  
**RAUL R. FUECUNCILLO**  
PGDH-Provincial Agriculture  
SBAC Member

  
**DANILO P. CADUNGOG**  
(PGDH-PCO)  
SBAC Member

  
**Engr. RODERICK R. MILANA, REA**  
HRMO IV, PGO-HRMO  
SBAC Vice Chairperson

  
**DESSAMIE BUATIS SANCHEZ, CPA**  
Provincial Budget Officer  
SBAC Chairperson – Presiding Officer

Approved:

  
**DOUGLAS RA. CAGAS, LLB, MBE, MNSA**  
Governor  
Head of the Procuring Entity





Republic of the Philippines  
PROVINCE OF DAVAO DEL SUR  
Barangay Matti, Digos City, Davao del Sur  
Email: sbadavao@skm@gmail.com  
Mobile Number: 0948 703 5548

EXCERPT FROM THE MINUTES OF THE REGULAR MEETING OF THE SPECIAL BIDS AND AWARDS COMMITTEE HELD ON JANUARY 06, 2022, 10:30 A.M., AT THE RALOTA HALL OF THE GOVERNOR DOUGLAS RALOTA CAGAS SPORTS AND BUSINESS COMPLEX, BRGY. MATTI, DIGOS CITY, AND VIA VIDEOCONFERENCE ON GOOGLE MEET, WITH ROOM ID: rcc-epus-vyp (<http://meet.google.com/rcc-epus-vyp>)

Present:

Dessamie Buat- Sanchez, CPA, JD  
Engr. Roderick R. Milana, REA  
Geraldine S. Lano, RSW, MPA  
Raul R. Fueconillo, MagDev  
Engr. Leonel March P. Suarico  
Engr. Leofer C. Alviola  
Engr. Luzviminda G. Cortijos  
Emmanuel G. Escarcha  
Gypsy Jennisen C. Arquio  
Engr. Shieia Mae A. Zapanta, MPA  
Mark Wayne C. Apa, MBA

SBAC Chairperson - Presiding Officer  
SBAC Vice- Chairperson  
SBAC Member  
SBAC Member  
SBAC Member  
SBAC- TWG Member  
SBAC- TWG Member  
SBAC- TWG Member  
Head- SBAC Secretariat (on study leave)  
Member - SBAC Secretariat  
Member - SBAC Secretariat

Quorum

Resolution No. 007  
Series of 2022

#### A RESOLUTION

RECOMMENDING TO THE HEAD OF THE PROCURING ENTITY, GOVERNOR MARC DOUGLAS W. C. CAGAS, TO DECLARE BIDDERS WHO FAILED TO DISCLOSE ALL ON-GOING PROJECTS AS DISQUALIFIED, AFTER FINDING SUCH NON-CLUSION DURING POST-QUALIFICATION OF BIDDERS BY THE SBAC TECHNICAL WORKING GROUP (TWG)

Be it enacted by the SBAC MEMBERS in meeting assembled:

WHEREAS, in line with the Provincial Government of Davao del Sur's initiative to fast-track the procurement transactions of the Province, the Special Bids and Awards Committee thereby adopts this Resolution to produce Contractors with integrity and truthfulness in their submitted bid;

WHEREAS, item number 2 of GPPB NPM 111-2013 states that, "Failure to include all on-going and completed contracts in the Statement may be a ground for disqualification for being incomplete, and may also result in blacklisting if proven that such failure amounts to submission of false information or false documents. The submission of the eligibility documents enumerated in Section 23.1 of the IRR is a mandatory requirement that must be complied with by prospective bidders, such that failure to submit any of the documents or the submission of an otherwise incomplete or patently insufficient document, will disqualify the bidder based on the non-discretionary "pass/fail" criterion under Section 30.1 of the IRR."

IN ADDITION, GPPB NPM 006-2018 states that, "Failure to declare an on-going government and private contract, including contracts awarded but not yet started, if any,

SBAC Resolution No. 007, Series of 2022

Page 1 of 3

whether similar or not similar in nature and complexity to the contract to be bid is a ground for disqualification. These contracts, as reflected in the "Statement of all on-going contracts", are vital to the computation of the Net Financial Contracting Capacity of the bidder, and they are necessary information during the post-qualification stage to verify, validate and ascertain the technical qualification of the Lowest Calculated Bidder for the ultimate determination whether it is the Lowest Calculated and Responsive Bidder.":

WHEREFORE, after thorough deliberation, SBAC Vice-Chairperson Milana duly seconded by SBAC Member Fueconcillo, it was-

RESOLVED, as it is hereby RESOLVED, to recommend to the HEAD OF PROCURING ENTITY, GOVERNOR MARC DOUGLAS W. C. CAGAS, TO DECLARE BIDDERS WHO FAILED TO DISCLOSE ALL ON-GOING PROJECTS AS DISQUALIFIED AFTER FINDING SUCH NON-INCLUSION DURING POST-QUALIFICATION OF BIDDERS BY THE SBAC TECHNICAL WORKING GROUP (TWG);

RESOLVED FINALLY, to furnish copies of this Resolution to all agencies concerned for their information and guidance.

UNANIMOUSLY APPROVED,

Prepared by:



MARK WAYNE C. APA, MBA  
LAOO II  
SBAC Secretariat Member

I hereby certify to the correctness of above-mentioned resolution

Engr. SHIELA MAE ZAPANTA, MPA  
Agricultural Technologist  
SBAC Secretariat Member

Attested by:



GERALDINE S. LANO, RSW, MPA  
PGDH-Provincial Social Welfare Officer  
SBAC Member



RAUL R. FUECONCILLO, MagDev  
PGDH-Provincial Agriculturist  
SBAC Member

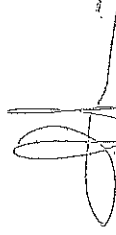

Engr. LEONEL MARCH P. SUARIO  
PGDH-Provincial Engineer  
SBAC Member



Engr. RODERICK R. MILANA, REA  
PGDH-Provincial Assessor  
SBAC Vice-Chairperson



  
DESSAIME BUAT-SANCHEZ, CPA, JD  
FGDH - Provincial Budget Officer  
SBAC Chairperson -- Presiding Officer

Approved by:

MARC DOUGLAS IV C. CAGAS  
Governor  
Head of Procuring Entity

BY AUTHORITY OF THE GOVERNOR  
  
CHRISTOPHER T. TAN  
GOVERNOR  
OFFICE OF THE PROVINCIAL GOVERNMENT

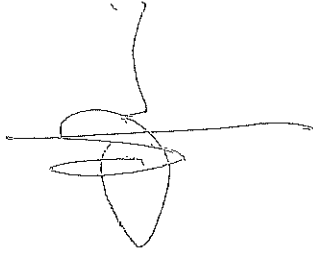



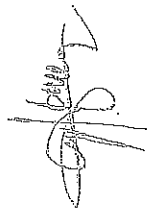





**PROCUREMENT MANAGEMENT OFFICE  
BIDS AND AWARDS COMMITTEE**



Mobile Nos. 0905-229-0526/0908-332-2024 (Goods), 0948-768-5848 (Infra)

Telefax: (082) 553-9579

Website: [www.davaodelsur.gov.ph/pgc-bac](http://www.davaodelsur.gov.ph/pgc-bac)

Email Add.: [bac.davaodelsur2@gmail.com](mailto:bac.davaodelsur2@gmail.com)/[sbacdavaodelsur@gmail.com](mailto:sbacdavaodelsur@gmail.com)

*Provincia de Davao del Sur*

**TWG – CHECKLIST FOR BID EVALUATION**

IB No.	Name of Project:	FINDINGS	REMARKS
<b>Contractor:</b>			
<b>ITEMS:</b>			
1.	Bid Amount (both in words and in figure) must be below ABC.		
2.	Bill of Quantities submitted by the contractor must conform with the Bill of Quantities issued by the End-User.		
3.	Detailed Estimates		
	A. Check mathematical computation in the Detailed Estimates		
	B. The amount in the Detailed Estimates must be reconciled with the amount in the summary of bid and the quantities in the BOQ.		
	C. Allowance for waste and/or losses, not to exceed 5% of materials equipment.		
	D. Mobilization and demobilization shall not exceed 1% of the Estimated Direct Cost (EDC) of the civil works items.		
	E. Overhead expenses must be within the range of %-11% of the EDC.		
	F. Contingencies must be within the range of 0.5%-3% of the EDC.		
	G. Miscellaneous expenses must be within the range of 0.5%-1% of the EDC.		
	H. Contractor's Profit Margin shall be 8% of the EDC for projects above 5 million and <b>10% for the projects 5 million and below.</b>		
	I. VAT Component shall be 5% of the sum of the EDC, OCM, and Profit.		
	J. The following non-civil work items shall not be subjected to OCM mark-up:		
	1. Field/ Laboratory Office & Living Quarters (Rental Basis)		
	2. Furnishing of Furniture, Laboratory Equipment, Survey Equipment and Consumables		
	3. Assistance to the Engineers		
	4. Photographs		
	<b>5. Health and Safety</b>		
	2. Traffic Management		
	3. Environmental Compliance		
	4. Communication Equipment		
	<b>5. Project Billboard, etc.</b>		

P  
M  
O



Manayays  
Luzon  
Paraiso

Republic of the Philippines  
PROVINCE OF DAVAO DEL SUR  
Office of the Governor

# PROCUREMENT MANAGEMENT OFFICE BIDS AND AWARDS COMMITTEE

Mobile Nos. 0905-229-0526/0908-332-2024 (Goods), 0948-768-5848 (Infra)

Telefax: (082) 553-9579

Website: [www.davaodelsur.gov.ph/pgo-bac](http://www.davaodelsur.gov.ph/pgo-bac)

Email Add.: [bac.davaodelsur2@gmail.com](mailto:bac.davaodelsur2@gmail.com)/[sbaccdavaodelsur@gmail.com](mailto:sbaccdavaodelsur@gmail.com)

*92nd Davao del Sur*

K. The following items shall not be subjected to OCM and Profit mark-up:		
<b>A. Mobilization and demobilization</b>		
B. Provision of Service Vehicle		
<b>C. Permits and Clearances</b>		
<b>4. Bid Security</b>		
A. Cash or Cashier's/ Manager's check (2%)		
B. Bank Guarantee/ Draft or Irrevocable Letter of Credit (2%)		
C. Surety Bond callable upon demand (5%)		
<b>D. Bid Securing Declaration (must be in prescribed form, 15 days)</b>		
E. Cash Flow by quarter and payment schedule (check mathematical computation against the bid amount)		



# PROCUREMENT MANAGEMENT OFFICE

## BIDS AND AWARDS COMMITTEE

Mobile Nos. 0905-229-0526/0908-332-2024 (Goods), 0948-768-5848 (Infra)  
Telefax: (082) 553-9579

Website: [www.davaodelsur.gov.ph/pgo-bac](http://www.davaodelsur.gov.ph/pgo-bac)

Email Add.: [bac.davaodelsur2@gmail.com](mailto:bac.davaodelsur2@gmail.com)/[sba@davaodelsur@gmail.com](mailto:sba@davaodelsur@gmail.com)

*9 Years Davao del Sur*

### TWG – CHECKLIST FOR POST QUALIFICATION

IB. No.	Name of Project:	FINDINGS	REMARKS
	<b>Contractor:</b>		
	<b>TECHNICAL DOCUMENTS:</b>		
	1. Not a Blacklisted Contractor per GPPB Website		
	2. Registration certificate from SEC, Department of Trade and Industry (DTI) for sole proprietorship, or CDA for cooperatives must be valid (Company Name and Validity)		
	3. Mayor's/ Business permit must be valid (Company Name and Validity)		
	4. Tax Clearance must be valid (Company Name and Validity)		
	5. PhilGEPS Registration (Platinum Membership) must be valid (Company Name and Validity)		
	6. Valid Philippine Contractors Accreditation Board or Special PCAB License in case of Joint Ventures (PCAB)		
	7. Statement of all on-going government and private contracts including awarded but not yet started		
	A. Complete attachments		
	I. Notice of Award		
	II. Contract		
	III. Notice to Proceed		
	IV. Contract Extension, if any;		
	V. Statement of Work Accomplishment duly signed by the Procuring Entity		
	B. Evaluate the projects, if any;		
	i. Verify Target Date of Completion		
	ii. Must not incur Negative Slippage of more than fifteen percent (15%) in any one project or a negative slippage of more than ten percent (10%) in each two (2) or more contracts.		
	C. Verification of on-going projects via DPWH portal		
	8. Statement of the bidder's Single Largest Completed Contract (SLCC) similar to the contract to be bid for the last (3) years, and whose value, adjusted to current prices using the PSA consumer price indices, must be at least fifty percent (50%) of the ABC to be bid: Provided, however, that contractors under Small A and Small B categories without similar experience on the contract to be bid may be allowed to bid if the cost of such contract is not more than the Allowable Range of Contract Cost (ARCC) of their registration based on the guidelines as prescribed by the PCAB.		
	Must be supported with the following:		
	A. Contract / Purchase Order		
	B. Certificate of Completion / Acceptance or Inspection Report or Official Receipt		
	C. Validate Contractors/Constructors Performance Evaluation System (CPES) in DPWH website.		

P M O

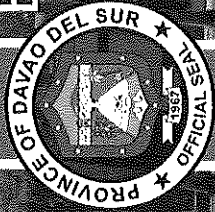

Masangay  
Paglilingkod

Republic of the Philippines  
PROVINCE OF DAVAO DEL SUR  
Office of the Governor

# PROCUREMENT MANAGEMENT OFFICE BIDS AND AWARDS COMMITTEE

Mobile Nos. 0905-229-0526/0908-332-2024 (Goods), 0948-768-5848 (Infra)  
Telefax: (082) 553-9579

Website: [www.davaodelsur.gov.ph/pgo-bac](http://www.davaodelsur.gov.ph/pgo-bac)

Email Add: [bac.davaodelsur@gmail.com](mailto:bac.davaodelsur@gmail.com)/[sbacdavaodelsur@gmail.com](mailto:sbacdavaodelsur@gmail.com)

*Ng Lipa Davao del Sur*

9. Omnibus Sworn Statement must be in prescribed form (1 to 9) and duly notarized		
10. Net Financial Contracting Capacity (NFCC) must be reconciled with the Audited Financial Statements		
11. Income Tax Return as of 2020		
12. Business Tax Return Quarterly or Monthly as of 2021		
13. Construction Methods must conform with the approved plan		
14. Construction schedule and S-Curve must conform with the prescribed contract duration and the bid amount		
15. PERT-CPM must conform with the contract duration		
16. Manpower Utilization must conform with the POW		
17. Equipment Utilization must conform with the POW		
18. Duly Notarized Affidavit of Site Inspection		
19. Duly Notarized Compliance to Existing Labor Laws and Standards		