

**P M O**

Republic of the Philippines  
PROVINCE OF DAVAO DEL SUR  
Office of the Governor

# PROCUREMENT MANAGEMENT OFFICE BIDS AND AWARDS COMMITTEE



Maanabo  
TIGER  
Patriotic

Mobile Nos. 0905-229-0526/0908-332-2024 (Goods), 0948-768-5848 (Infra)  
Telefax: (082) 553-9579

Website: [www.davaodelsur.gov.ph/pgo-bac](http://www.davaodelsur.gov.ph/pgo-bac)

Email Address: [bac.davaodelsur2@gmail.com](mailto:bac.davaodelsur2@gmail.com) / [sbacdavaoocelsur@gmail.com](mailto:sbacdavaoocelsur@gmail.com)

*Ag Rice Davao del Sur*

## BIDDING DOCUMENTS

### One Job Order for the **IMPROVEMENT OF FARM TO MARKET ROAD (FMR) located at LAPERAS, SULOP, DAVAO DEL SUR**

all in accordance to plans, specifications and scope of work and the Green Procurement Policy as adopted by Executive Order No. 30 series of 2019

**IB No. C-086-23**

**Date of Opening of Bids: July 25, 2023 at 09:00 A.M.  
Start Date for Issuance of Bidding Documents: July 6, 2023**

Sixth Edition  
July 2020

hi

## TABLE OF CONTENTS

SECTION I.	INVITATION TO BID
SECTION II.	INSTRUCTIONS TO BIDDERS
SECTION III.	BID DATA SHEET
SECTION IV.	GENERAL CONDITIONS OF CONTRACT
SECTION V.	SPECIAL CONDITIONS OF CONTRACT
SECTION VI.	SPECIFICATIONS
SECTION VII.	DRAWINGS
SECTION VIII.	BILL OF QUANTITIES
SECTION IX.	CHECKLIST OF TECHNICAL AND FINANCIAL DOCUMENTS
SECTION X.	OTHER DOCUMENTS

H

**SECTION I.**  
**INVITATION TO BID**

16

**SECTION II.**

**INSTRUCTION TO BIDDERS**

4

## *Section II. Instructions to Bidders*

### **1. Scope of Bid**

The **IMPROVEMENT OF FARM TO MARKET ROAD (FMR)** located at **LAPERAS, SULOP, DAVAO DEL SUR**, with Project Identification Number **C-086-23**.

The Procurement Project (referred to herein as “**IMPROVEMENT OF FARM TO MARKET ROAD (FMR)** located at **LAPERAS, SULOP, DAVAO DEL SUR**”) is for the construction of Works, as described in Section VI (Specifications).

### **2. Funding Information**

2.1. The GOP through the source of funding as indicated below for **CY 2023** in the amount of **P2,000,000.00**.

2.2. The source of funding is **20% DEVT FUND**:

### **3. Bidding Requirements**

The Bidding for the Project shall be governed by all the provisions of RA No. 9184 and its 2016 revised IRR, including its Generic Procurement Manual and associated policies, rules and regulations as the primary source thereof, while the herein clauses shall serve as the secondary source thereof.

Any amendments made to the IRR and other GPPB issuances shall be applicable only to the ongoing posting, advertisement, or invitation to bid by the BAC through the issuance of a supplemental or bid bulletin.

The Bidder, by the act of submitting its Bid, shall be deemed to have inspected the site, determined the general characteristics of the contracted Works and the conditions for this Project, such as the location and the nature of the work; (b) climatic conditions; (c) transportation facilities; (c) nature and condition of the terrain, geological conditions at the site communication facilities, requirements, location and availability of construction aggregates and other materials, labor, water, electric power and access roads; and (d) other factors that may affect the cost, duration and execution or implementation of the contract, project, or work and examine all instructions, forms, terms, and project requirements in the Bidding Documents.

### **4. Corrupt, Fraudulent, Collusive, Coercive, and Obstructive Practices**

The Procuring Entity, as well as the Bidders and Contractors, shall observe the highest standard of ethics during the procurement and execution of the contract. They or through an agent shall not engage in corrupt, fraudulent, collusive, coercive, and obstructive practices defined under Annex “I” of the 2016 revised IRR of RA No. 9184 or other integrity violations in competing for the Project.

### **5. Eligible Bidders**

5.1. Only Bids of Bidders found to be legally, technically, and financially capable will be evaluated.

5.2. The Bidder must have an experience of having completed a Single Largest Completed Contract (SLCC) that is similar to this Project, equivalent to at least fifty percent (50%) of the ABC adjusted, if necessary, by the Bidder to current prices using the PSA’s CPI,

except under conditions provided for in Section 23.4.2.4 of the 2016 revised IRR of RA No. 9184.

fr

A contract is considered to be “similar” to the contract to be bid if it has the major categories of work stated in the **BDS**.

- 5.3. For Foreign-funded Procurement, the Procuring Entity and the foreign government/foreign or international financing institution may agree on another track record requirement, as specified in the Bidding Document prepared for this purpose.
- 5.4. The Bidders shall comply with the eligibility criteria under Section 23.4.2 of the 2016 IRR of RA No. 9184.

## **6. Origin of Associated Goods**

There is no restriction on the origin of Goods other than those prohibited by a decision of the UN Security Council taken under Chapter VII of the Charter of the UN.

## **7. Subcontracts**

- 7.1. Subcontracting is not allowed.

## **8. Pre-Bid Conference**

The Procuring Entity will hold a pre-bid conference for this Project on the **July 13, 2023, at 9:00 A.M., Ralota Hall, Gov. Douglas Ra. Cagas Cultural Sports and Business Complex, Barangay Maffi, Digos City, Davao del Sur** as indicated in paragraph 6 of the IB.

## **9. Clarification and Amendment of Bidding Documents**

Prospective bidders may request for clarification on and/or interpretation of any part of the Bidding Documents. Such requests must be in writing and received by the Procuring Entity, either at its given address or through electronic mail indicated in the IB, at least ten (10) calendar days before the deadline set for the submission and receipt of Bids.

## **10. Documents Comprising the Bid: Eligibility and Technical Components**

- 10.1. The first envelope shall contain the eligibility and technical documents of the Bid as specified in **Section IX. Checklist of Technical and Financial Documents**.
- 10.2. If the eligibility requirements or statements, the bids, and all other documents for submission to the BAC are in foreign language other than English, it must be accompanied by a translation in English, which shall be authenticated by the appropriate Philippine foreign service establishment, post, or the equivalent office having jurisdiction over the foreign bidder's affairs in the Philippines. For Contracting Parties to the Apostille Convention, only the translated documents shall be authenticated through an apostille pursuant to GPPB Resolution No. 13-2019 dated 23 May 2019. The English translation shall govern, for purposes of interpretation of the bid.
- 10.3. A valid special PCAB License in case of Joint Ventures, and registration for the type and cost of the contract for this Project. Any additional type of Contractor license or permit shall be indicated in the **BDS**.
- 10.4. A List of Contractor's key personnel (e.g., Project Manager, Project Engineers, Materials Engineers, and Foremen) assigned to the contract to be bid, with their complete qualification and experience data shall be provided. These key personnel must meet the required minimum years of experience set in the **BDS**.
- 10.5. A List of Contractor's major equipment units, which are owned, leased, and/or under purchase agreements, supported by proof of ownership, certification of availability of

## **11. Documents Comprising the Bid: Financial Component**

- 11.1. The second bid envelope shall contain the financial documents for the Bid as specified in **Section IX. Checklist of Technical and Financial Documents**.
- 11.2. Any bid exceeding the ABC indicated in paragraph 1 of the **IB** shall not be accepted.
- 11.3. For Foreign-funded procurement, a ceiling may be applied to bid prices provided the conditions are met under Section 31.2 of the 2016 revised IRR of RA No. 9184.

## **12. Alternative Bids**

Bidders shall submit offers that comply with the requirements of the Bidding Documents, including the basic technical design as indicated in the drawings and specifications. Unless there is a value engineering clause in the **BDS**, alternative Bids shall not be accepted.

## **13. Bid Prices**

All bid prices for the given scope of work in the Project as awarded shall be considered as fixed prices, and therefore not subject to price escalation during contract implementation, except under extraordinary circumstances as determined by the NEDA and approved by the GPPB pursuant to the revised Guidelines for Contract Price Escalation guidelines.

## **14. Bid and Payment Currencies**

- 14.1. Bid prices may be quoted in the local currency or tradeable currency accepted by the BSP at the discretion of the Bidder. However, for purposes of bid evaluation, Bids denominated in foreign currencies shall be converted to Philippine currency based on the exchange rate as published in the BSP reference rate bulletin on the day of the bid opening.
- 14.2. Payment of the contract price shall be made in: **Philippine Pesos**.

## **15. Bid Security**

- 15.1. The Bidder shall submit a Bid Securing Declaration or any form of Bid Security in the amount indicated in the **BDS**, which shall be not less than the percentage of the ABC in accordance with the schedule in the **BDS**.
- 15.2. The Bid and bid security shall be valid for **120 Calendar Days** upon opening of bids. Any bid not accompanied by an acceptable bid security shall be rejected by the Procuring Entity as non-responsive.

## **16. Sealing and Marking of Bids**

Each Bidder shall submit one copy of the first and second components of its Bid.

The Procuring Entity may request additional hard copies and/or electronic copies of the Bid. However, failure of the Bidders to comply with the said request shall not be a ground for disqualification.

If the Procuring Entity allows the submission of bids through online submission to the given website or any other electronic means, the Bidder shall submit an electronic copy of its Bid, which must be digitally signed. An electronic copy that cannot be opened or is corrupted shall be considered non-responsive and, thus, automatically disqualified.

## **17. Deadline for Submission of Bids**

17.1 Bids must be delivered to the Ralota Hall, Gov. Douglas Ra. Cagas Cultural Sports and Business Complex, Barangay Matti, Digos City, Davao del Sur **on or before July 25, 2023 at 9:00 A.M.** Late bids shall not be accepted. All bids must be accompanied by a bid security in any of the acceptable forms and in the amount stated in ITB Clause 18.

## **18. Opening and Preliminary Examination of Bids**

18.1. The BAC shall open the Bids in public at the time, on the date, and at the place specified in paragraph 9 of the **IB**. The Bidders' representatives who are present shall sign a register evidencing their attendance. In case videoconferencing, webcasting or other similar technologies will be used, attendance of participants shall likewise be recorded by the BAC Secretariat.

In case the Bids cannot be opened as scheduled due to justifiable reasons, the rescheduling requirements under Section 29 of the 2016 revised IRR of RA No. 9184 shall prevail.

18.2. The preliminary examination of Bids shall be governed by Section 30 of the 2016 revised IRR of RA No. 9184.

## **19. Detailed Evaluation and Comparison of Bids**

19.1. The Procuring Entity's BAC shall immediately conduct a detailed evaluation of all Bids rated "*passed*" using non-discretionary pass/fail criteria. The BAC shall consider the conditions in the evaluation of Bids under Section 32.2 of 2016 revised IRR of RA No. 9184.

19.2. If the Project allows partial bids, all Bids and combinations of Bids as indicated in the **BDS** shall be received by the same deadline and opened and evaluated simultaneously so as to determine the Bid or combination of Bids offering the lowest calculated cost to the Procuring Entity. Bid Security as required by **ITB** Clause 15 shall be submitted for each contract (lot) separately.

19.3. In all cases, the NFCC computation pursuant to Section 23.4.2.6 of the 2016 revised IRR of RA No. 9184 must be sufficient for the total of the ABCs for all the lots participated in by the prospective Bidder.

## **20. Post Qualification**

Within a non-extendible period of five (5) calendar days from receipt by the Bidder of the notice from the BAC that it submitted the Lowest Calculated Bid, the Bidder shall submit its latest income and business tax returns filed and paid through the BIR Electronic Filing and Payment System (eFPS), and other appropriate licenses and permits required by law and stated in the **BDS**.

## **21. Signing of the Contract**

The documents required in Section 37.2 of the 2016 revised IRR of RA No. 9184 shall form part of the Contract. Additional Contract documents are indicated in the **BDS**.

H



**SECTION III.**

**BID DATA SHEET**

H

# Bid Data Sheet

(IB No.: C-086-23)

<b>ITB Clause</b>							
5.2	For this purpose, contracts similar to the Project refer to contracts which have the same major categories of work, which shall be:  <b>Roads: Construction or Rehabilitation</b> <b>(based on DPWH DO 14 Series of 2017)</b> <b>Subcontracting is not allowed.</b>						
7.1							
10.3	"No further instructions."						
10.4	The key personnel must meet the required minimum years of experience set below: <table border="1"><thead><tr><th><u>Key Personnel</u></th><th><u>General Experience</u></th><th><u>Relevant Experience</u></th></tr></thead><tbody><tr><td></td><td></td><td></td></tr></tbody></table>	<u>Key Personnel</u>	<u>General Experience</u>	<u>Relevant Experience</u>			
<u>Key Personnel</u>	<u>General Experience</u>	<u>Relevant Experience</u>					
10.5	"No further instructions." The minimum major equipment requirements are the following: <table border="1"><thead><tr><th><u>Equipment</u></th><th><u>Capacity</u></th><th><u>Number of Units</u></th></tr></thead><tbody><tr><td></td><td></td><td></td></tr></tbody></table>	<u>Equipment</u>	<u>Capacity</u>	<u>Number of Units</u>			
<u>Equipment</u>	<u>Capacity</u>	<u>Number of Units</u>					
12	"No further instructions." None.						
15.1	The bid security shall be in the form of a Bid Securing Declaration or any of the following forms and amounts: a. The amount of <b>not less than P40,000.00</b> [two percent (2%) of ABC], if bid security is in cash, cashier's/manager's check, bank draft/guarantee or irrevocable letter of credit; b. The amount of <b>not less than P100, 000.00</b> [five percent (5%) of ABC], if bid security is in Surety Bond.						
19.2	Partial bid is not allowed. The infrastructure project is packaged in a single lot and the lot shall not be divided into sub-lots for the purpose of bidding, evaluation, and contract award.  In all cases, the NFCC computation must be sufficient for the contract to be awarded to the Bidder.  <i>Permits and Clearances as required by the End-User.</i>						
20	<b>Post-Qualification Requirements: Latest Income Tax Returns, Business Tax Returns for the last 6 months.</b>						
21	1. Presentation of the Bidding Documents a. <b>Envelope 1 (Eligibility/ Technical Documents)</b> One (1) ORIGINAL COPY, another copy for COPY 1, and another copy for COPY 2. b. <b>Envelope 2 (Financial Proposal)</b> One (1) ORIGINAL COPY, another copy for COPY 1, and another copy for COPY 2.  Such documents shall be duly signed by the bidders or its duly authorized representative/s.  Eligibility/Technical and Financial Proposal must be book bound and properly						

h

tabbed at the right side. Any documents submitted not book bound shall be rejected outright. For the Financial Proposal not exceeding ten (10) pages maybe book bound or securely stapled.

All copies must be properly marked (ORIGINAL COPY, COPY 1 AND COPY 2)

**Envelope 1 and Envelope 2 must be properly sealed, and will be placed in one sealed mother envelope.**

2. Other documents/materials to comply with other non-discretionary criteria and requirements as stated in the Instruction to Bidders:

- **Construction Methods**
- **Construction schedule and S-Curve**
- **Pert-CPM**
- **Manpower Utilization Schedule**
- **Equipment Utilization Schedule**
- **Construction Safety & Health Program**
- **Affidavit of Site Inspection**
- **Duly Notarized Certification as to compliance to Labor Laws and Standard**

The DOLE approved Construction Safety and Health Program is required before entering into Contract.

fr

**SECTION IV.**

**GENERAL CONDITIONS  
OF CONTRACT**

*h*

# *General Conditions of Contract*

## **1. Scope of Contract**

This Contract shall include all such items, although not specifically mentioned, that can be reasonably inferred as being required for its completion as if such items were expressly mentioned herein. All the provisions of RA No. 9184 and its 2016 revised IRR, including the Generic Procurement Manual, and associated issuances, constitute the primary source for the terms and conditions of the Contract, and thus, applicable in contract implementation. Herein clauses shall serve as the secondary source for the terms and conditions of the Contract.

This is without prejudice to Sections 74.1 and 74.2 of the 2016 revised IRR of RA No. 9184 allowing the GPPB to amend the IRR, which shall be applied to all procurement activities, the advertisement, posting, or invitation of which were issued after the effectivity of the said amendment.

## **2. Sectional Completion of Works**

If sectional completion is specified in the Special Conditions of Contract (SCC), references in the Conditions of Contract to the Works, the Completion Date, and the Intended Completion Date shall apply to any Section of the Works (other than references to the Completion Date and Intended Completion Date for the whole of the Works).

## **3. Possession of Site**

3.1 The Procuring Entity shall give possession of all or parts of the Site to the Contractor based on the schedule of delivery indicated in the SCC, which corresponds to the execution of the Works. If the Contractor suffers delay or incurs cost from failure on the part of the Procuring Entity to give possession in accordance with the terms of this clause, the Procuring Entity's Representative shall give the Contractor a Contract Time Extension and certify such sum as fair to cover the cost incurred, which sum shall be paid by Procuring Entity.

3.2 If possession of a portion is not given by the above date, the Procuring Entity will be deemed to have delayed the start of the relevant activities. The resulting adjustments in contract time to address such delay may be addressed through contract extension provided under Annex "E" of the 2016 revised IRR of RA No. 9184.

## **4. The Contractor's Obligations**

The Contractor shall employ the key personnel named in the Schedule of Key Personnel indicating their designation, in accordance with ITB Clause 10.3 and specified in the **BDS**, to carry out the supervision of the Works.

The Procuring Entity will approve any proposed replacement of key personnel only if their relevant qualifications and abilities are equal to or better than those of the personnel listed in the Schedule.

## **5. Performance Security**

5.1. Within ten (10) calendar days from receipt of the Notice of Award from the Procuring Entity but in no case later than the signing of the contract by both parties, the successful

Bidder shall furnish the performance security in any of the forms prescribed in Section 39 of the 2016 revised IRR.

5.2. The Contractor, by entering into the Contract with the Procuring Entity, acknowledges the right of the Procuring Entity to institute action pursuant to RA No. 3688 against any subcontractor be they an individual, firm, partnership, corporation, or association supplying the Contractor with labor, materials and/or equipment for the performance of this Contract.

## **6. Site Investigations**

The Contractor, in preparing the Bid, shall rely on any Site Investigation Reports referred to in the SCC supplemented by any information obtained by the Contractor.

## **7. Warranty**

7.1. In case the Contractor fails to undertake the repair works under Section 62.2.2 of the 2016 revised IRR, the Procuring Entity shall forfeit its performance security, subject its property(ies) to attachment or garnishment proceedings, and perpetually disqualify it from participating in any public bidding. All payables of the GOP in his favor shall be offset to recover the costs.

7.2. The warranty against Structural Defects/Failures, except that occasioned-on force majeure, shall cover the period from the date of issuance of the Certificate of Final Acceptance by the Procuring Entity. Specific duration of the warranty is found in the SCC.

## **8. Liability of the Contractor**

Subject to additional provisions, if any, set forth in the SCC, the Contractor's liability under this Contract shall be as provided by the laws of the Republic of the Philippines.

If the Contractor is a joint venture, all partners to the joint venture shall be jointly and severally liable to the Procuring Entity.

## **9. Termination for Other Causes**

Contract termination shall be initiated in case it is determined prima facie by the Procuring Entity that the Contractor has engaged, before, or during the implementation of the contract, in unlawful deeds and behaviors relative to contract acquisition and implementation, such as, but not limited to corrupt, fraudulent, collusive, coercive, and obstructive practices as stated in ITB Clause 4.

## **10. Dayworks**

Subject to the guidelines on Variation Order in Annex "E" of the 2016 revised IRR of RA No. 9184, and if applicable as indicated in the SCC, the Dayworks rates in the Contractor's Bid shall be used for small additional amounts of work only when the Procuring Entity's Representative has given written instructions in advance for additional work to be paid for in that way.

## **11. Program of Work**

11.1. The Contractor shall submit to the Procuring Entity's Representative for approval the said Program of Work showing the general methods, arrangements, order, and timing for all

hr

the activities in the Works. The submissions of the Program of Work are indicated in the SCC.

11.2. The Contractor shall submit to the Procuring Entity's Representative for approval an updated Program of Work at intervals no longer than the period stated in the SCC. If the Contractor does not submit an updated Program of Work within this period, the Procuring Entity's Representative may withhold the amount stated in the SCC from the next payment certificate and continue to withhold this amount until the next payment after the date on which the overdue Program of Work has been submitted.

## **12. Instructions, Inspections and Audits**

The Contractor shall permit the GOP or the Procuring Entity to inspect the Contractor's accounts and records relating to the performance of the Contractor and to have them audited by auditors of the GOP or the Procuring Entity, as may be required.

## **13. Advance Payment**

The Procuring Entity shall, upon a written request of the Contractor which shall be submitted as a Contract document, make an advance payment to the Contractor in an amount not exceeding fifteen percent (15%) of the total contract price, to be made in lump sum, or at the most two installments according to a schedule specified in the SCC, subject to the requirements in Annex "E" of the 2016 revised IRR of RA No. 9184.

## **14. Progress Payments**

The Contractor may submit a request for payment for Work accomplished. Such requests for payment shall be verified and certified by the Procuring Entity's Representative/Project Engineer. Except as otherwise stipulated in the SCC, materials and equipment delivered on the site but not completely put in place shall not be included for payment.

## **15. Operating and Maintenance Manuals**

15.1. If required, the Contractor will provide "as built" Drawings and/or operating and maintenance manuals as specified in the SCC.

15.2. If the Contractor does not provide the Drawings and/or manuals by the dates stated above, or they do not receive the Procuring Entity's Representative's approval, the Procuring Entity's Representative may withhold the amount stated in the SCC from payments due to the Contractor.

16

**SECTION V.**

**SPECIAL CONDITIONS  
OF CONTRACT**

4



# Special Conditions of Contract

GCC Clause	
2	<i>The Intended Completion Date is 40 calendar days upon receipt of the Notice to Proceed.</i>
4.1	<i>The Procuring Entity shall give possession in full the parts of the Site to the Contractor upon receipt of the Notice to Proceed.</i>
6	The site investigation reports are: <b>Site Inspection Report</b>
7.2	<i>[In case of semi-permanent structures, such as buildings of types 1, 2, and 3 as classified under the National Building Code of the Philippines, concrete/asphalt roads, concrete river control, drainage, irrigation lined canals, river landing, deep wells, rock causeway, pedestrian overpass, and other similar semi-permanent structures:] Five (5) years.</i>
10	a. Dayworks are applicable at the rate shown in the Contractor's original Bid.
11.1	"No further instruction."
11.2	"No further instruction."
13	<i>The amount of the advance payment shall not exceed <b>Fifteen Percent (15%) of the total contract price to be recouped every progress billing.</b></i>
14	Materials and equipment delivered on the site but not completely put in place shall not be included for payment.
15.1	"No further instructions."
15.2	The date by which "as built" drawings are required is <b>15 days prior turn-over and acceptance.</b>
	"No further instructions."

H

# **SECTION VI.**

## **SPECIFICATIONS**

[See attached file.]

H

Name of Project : **IMPROVEMENT OF FARM TO MARKET ROAD (FMR)**  
 Location : **LAPERAS, SULOP, DAVAO DEL SUR**

**SPECIFICATIONS**

<i>Item</i>	<i>Description</i>	<i>Unit</i>	<i>Quantity</i>
B-5	Project Billboard/Signboard	each	2.00
B.7(1)	Occupational Safety and Health Program	months	1.03
B.9	Mobilization/Demobilization	L.S.	1.00
100 (2)	Clearing & Grubbing	L.S.	1.00
102(2)	Surplus Common Excavation	cu.m.	491.77
104(2)a	Embankment from Borrow	cu.m.	107.00
105(1)a	Subgrade Preparation (Common Material)	sq.m.	653.04
200(1)	Aggregate Subbase Course	cu.m	324.68
311(1)b1	Portland Cement Concrete Pavement (Unreinforced), 200mm thk.	sq.m.	702.00

**NOTE:**

Specifications shall be in accordance with the DPWH Standard Specifications for Highways, Bridges, and Airport. Volume II 2013

Prepared by:

  
**JOSEPH RYAN B. REDOLOSO**  
 Engineer II

Reviewed by:

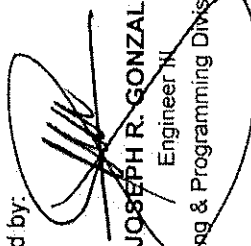
  
**JOSEPH R. GONZALES**  
 Engineer III  
 Planning & Programming Division Head

Approved by:

  
**ANGELIE R. GELLA**  
 PGADH - Assistant Provincial Engineer  
 OIC - Provincial Engineer  
 (As per Memo. Order No. 22-2023)

# **SECTION VII.**

## **DRAWINGS**

[The Detailed Architectural and Engineering Design is available at the Provincial Government of Davao del Sur, Procurement Management Office, Office of the BAC Secretariat for Infrastructure Projects, Room 16, Executive Building of Provincial Capitol, Mati, Digos City, upon purchase of the corresponding bidding documents.]

h

# **SECTION VIII.**

## **BILL OF QUANTITIES**

[See attached file.]

H

**BILL OF QUANTITIES**

Contract Name : IMPROVEMENT OF FARM TO MARKET ROAD (FMR)  
 Location of the Contract : LAPERAS, SULOP, DAVAO DEL SUR  
 Project Duration : 40 Calendar Days

**SUMMARY OF BID PRICES**  
 (All Parts of Bill of Quantities)

1. Part No. - Enter the "Part No." for each section of the Bill of Quantities (BOQ) where unit prices are entered.
2. Part Description - Enter the "Part Description" corresponding to the "Part No."
3. Total Amount - Enter the "total amount" in Pesos for all pages having the same "Part Description".
4. Adopting Green Procurement Policy by SBAC Resolution No. 140 series of 2019.

Contract ID:	Part No.	Part Description	Total Amount
	8.5	Project Billboard/Signboard	P
	B.7(1)	Occupational Safety and Health Program	P
	B.9	Mobilization/Demobilization	P
	100(2)	Clearing & Grubbing	P
	102(2)	Surplus Common Excavation	P
	104(2)a	Embankment from Borrow	P
	105(1)a	Subgrade Preparation (Common Material)	P
	200(1)	Aggregate Subbase Course	P
	311(1)b1	Portland Cement Concrete Pavement (Unreinforced), 200mm thk.	P
<b>Total of All Amounts</b>			<b>P</b>
Total of All Amounts in Words:			
PESOS			
and centavos			

Name : \_\_\_\_\_ In capacity of \_\_\_\_\_  
 Signed : \_\_\_\_\_ Date \_\_\_\_\_

Duly authorized to sign the Bid for and on behalf of \_\_\_\_\_

Contract Name : IMPROVEMENT OF FARM TO MARKET ROAD (FMR)

Location of the Contract : LAPERAS, SULOP, DAVAO DEL SUR

Project Duration : 40 Calendar Days

**BILL OF QUANTITIES**

Part No. \_\_\_\_\_

Pay Item No.	Description	Unit	Quantity	Unit Price (Pesos)	Amount (Pesos)
1	2	3	4	5	6
B.5	Project Billboard/Signboard	each	2.00	In words: _____ In figures: _____	In words: _____ In figures: _____
B.7(1)	Occupational Safety and Health Program	months	1.03	In words: _____ In figures: _____	In words: _____ In figures: _____
B.9	Mobilization/Demobilization	L.S.	1.00	In words: _____ In figures: _____	In words: _____ In figures: _____
100 (2)	Clearing & Grubbing	L.S.	1.00	In words: _____ In figures: _____	In words: _____ In figures: _____
102(2)	Surplus Common Excavation	cu.m.	491.77	In words: _____ In figures: _____	In words: _____ In figures: _____

Submitted by: \_\_\_\_\_

Name of the Representative of the Bidder \_\_\_\_\_

Position \_\_\_\_\_

Name of Bidder \_\_\_\_\_

Date : \_\_\_\_\_

Contract Name : IMPROVEMENT OF FARM TO MARKET ROAD (FMR)

Location of the Contract : LAPERAS, SULOP, DAVAO DEL SUR

Project Duration : 40 Calendar Days

**BILL OF QUANTITIES**

Part No. \_\_\_\_\_

Pay Item No. 1	Description 2	Unit 3	Quantity 4	Unit Price (Pesos) 5	Amount (Pesos) 6
104(2)a	Embankment from Borrow	cu.m.	107.00	In words: _____ In figures: _____	In words: _____ In figures: _____
105(1)a	Subgrade Preparation (Common Material)	sq.m.	653.04	In words: _____ In figures: _____	In words: _____ In figures: _____
200(1)	Aggregate Subbase Course	cu.m.	324.58	In words: _____ In figures: _____	In words: _____ In figures: _____
311(1)b1	Portland Cement Concrete Pavement (Unreinforced), 200mm thk.	sq.m.	702.00	In words: _____ In figures: _____	In words: _____ In figures: _____

Submitted by: \_\_\_\_\_

Name of the Representative of the Bidder \_\_\_\_\_

Position \_\_\_\_\_

Name of Bidder \_\_\_\_\_

Date : \_\_\_\_\_



## **SECTION IX.**

# **CHECKLIST OF TECHNICAL AND FINANCIAL DOCUMENTS**

40

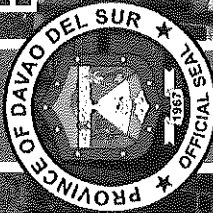

# PROCUREMENT MANAGEMENT OFFICE

## BIDS AND AWARDS COMMITTEE

Mobile Nos. 0905-229-0526/0908-332-2024 (Goods), 0948-768-5848 (Infra)  
Telefax: (082) 553-9579

Website: [www.davaodelsur.gov.ph/pgc-bac](http://www.davaodelsur.gov.ph/pgc-bac)

Email Add.: [bac.davaodelsur2@gmail.com](mailto:bac.davaodelsur2@gmail.com)/[baocdavaodelsur@gmail.com](mailto:baocdavaodelsur@gmail.com)

*Province of Davao del Sur*

### CHECKLIST-CIVIL

IB No:

Opening of Bids:

Name of Project/Brief Description of Goods:			
PR:	Dated:	ABC	End User:
Name of Contractor/Supplier:			
Address:			
Contact Number:			
<b>ENVELOPE 1- ELIGIBILITY DOCUMENTS/TECHNICAL</b>			
1. Class "A" Documents			
Legal Documents			
a. Valid PhilGEPS Registration Certificate (Platinum Membership) with its corresponding Annex A.			
Technical Documents			
b. Statement of the prospective bidder of all its on-going government and private contracts, including contracts awarded but not yet started (7 calendar days before the bid opening), if any, whether similar or not similar in nature and complexity to the contract to be bid with supporting documents such as Notice of Award and/or Contract, Notice to Proceed, and Certificate of Accomplishment or Statement of Time Elapsed and Work Accomplished.			
c. Statement of the bidder's Single Largest Completed Contract (SLCC) similar to the contract to be bid for the last (3) years, and whose value, adjusted to current prices using the PSA consumer price indices, must be at least fifty percent (50%) of the ABC to be bid: Provided, however, that contractors under Small A and Small B categories without similar experience on the contract to be bid may be allowed to bid if the cost of such contract is not more than the Allowable Range of Contract Cost (ARCC) of their registration based on the guidelines as prescribed by the PCAB. This Statement/ (ARCC) must be supported with the following: Contract/ Purchase Order, Certificate of Completion/ Acceptance or Inspection Report or Official Receipt, Validated Contractors/Constructors Performance Evaluation System (CPES) in DPWH website.			
d. Valid Philippine Contractors Accreditation Board (PCAB) License or Special PCAB License in case of Joint Ventures, and Registration for the type and cost of the contract to be bid.			
Financial Documents			
e. The prospective bidder's computation of Net Financial Contracting Capacity (NFCC). However, in the case of procurement of Goods, a bidder may submit a committed Line of Credit from a Universal or Commercial Bank, in lieu of its NFCC computation. (Note: K=15)			
2 Class "B" Documents			
a. For Infrastructure Projects, Joint Venture bidders shall submit a Joint Venture Agreement in accordance with R.A. 4566 and its IRR. Each partner of the joint venture shall submit their respective PhilGEPS Certificates of Registration in accordance with Section 8.5.2 of this IRR. The submission of technical and financial eligibility documents by any of the joint venture partners constitutes compliance: Provided, that the partner responsible to submit the NFCC shall likewise submit the Statement of all of its ongoing contracts and Audited Statements.			
<b>TECHNICAL PROPOSAL</b>			
1. Original copy of Bid Security in the form of the following: <ul style="list-style-type: none"> <li><input type="checkbox"/> Cash or Cashier's/ Manager's check (2%)</li> <li><input type="checkbox"/> Bank Guarantee/ Draft or Irrevocable Letter of Credit (2%)</li> <li><input type="checkbox"/> Surety Bond callable upon demand (5%)</li> <li><input type="checkbox"/> Bid Securing Declaration (in the prescribed form)</li> </ul>			
2. Project Requirements, which shall include the following: <ul style="list-style-type: none"> <li>a. Organizational chart for the contract to be bid</li> <li>b. List of contractor's personnel (viz., Project Manager, Project Engineers, Materials Engineers, and Foremen), to be assigned to the contract to be bid, with their complete qualifications and experience data;</li> </ul>			

4

	<p>c. List of contractor's equipment units, which are owned, leased, and/or under purchase agreements, supported by certification of availability of equipment from the equipment lessor/vendor for the duration of the project;</p>
	<p>3. Original Duly Signed Omnibus Sworn Statement (OSS) by the prospective bidder or its duly authorized representative; and if applicable, Original Notarized Secretary's Certificate in case of a corporation, partnership, or cooperative; or Original Special Power of Attorney of all members of the joint venture giving full power and authority to its officer to sign the OSS and do acts to represent the bidder.</p>
	<p>4. Other documents/materials to comply with other non-discretionary criteria and requirements as stated in the instruction to Bidders:</p> <ul style="list-style-type: none"> <li>• Construction Methods</li> <li>• Construction schedule and S-Curve</li> <li>• Pert-CPM</li> <li>• Manpower Utilization</li> <li>• Equipment Utilization</li> <li>• Construction Safety &amp; Health Program</li> <li>• Duly Notarized Affidavit of Site Inspection</li> <li>• Duly Notarized Certification as to Compliance to Labor Laws and Standard</li> </ul>
	QUALIFIED
	DISQUALIFIED
<b>ENVELOPE 2- FINANCIAL PROPOSAL</b>	
	1. Duly Signed Financial Bid Form
	2. Duly Signed Bid Prices in the Bill of Quantities
	3. Duly Signed Detailed Estimates
	4. Duly Signed Cash Flow by Quarter and Payment Schedules

H

# SECTION X.

## OTHER DOCUMENTS

- 1) Purchase Request
- 2) Statement of all On-going Government & Private Contracts including Contracts awarded but not yet started (Prescribed Form)
- 3) Statement of Single Largest Completed Contract (Prescribed Form)
- 4) Bid Securing Declaration (Prescribed Form)
- 5) Omnibus Sworn Statement (Prescribed Form)
- 6) Bid Form (Prescribed Form)
- 7) Resolution No. 047 Series of 2022 / Three-Strike Policy
- 8) Resolution No. 052 Series of 2022
- 9) Resolution No. 053 Series of 2022
- 10) TWG – Checklist for Bid Evaluation
- 11) TWG – Checklist for Post Qualification

48

**PURCHASE REQUEST**  
**PROVINCE OF DAVAO DEL SUR**  
MATTI, DIGOS CITY

Department : PROVINCIAL ENGINEER'S OFFICE PR NO. : OS6-23-S Date : 6/13/23  
Section : Construction SAI NO. : \_\_\_\_\_ Date : \_\_\_\_\_

STOCK No.	UNIT OF ISSUE	ITEM DESCRIPTION	QTY	UNIT COST	TOTAL COST
1	Job Order	<p><b>IMPROVEMENT OF FARM TO MARKET ROAD (FMR)</b> located at <b>LAPERAS, SULOP, DAVAO DEL SUR</b> all in accordance, to plans, specifications and scope of work and the Green Procurement Policy as adopted by Executive Order No. 30 series of 2019.</p> <p>XXXXXXXXXXXXXXXXXX  <b>TOTAL</b></p>	1	₱ 2,000,000.00 XXXXXXXXXX	
<p><b>TECHNICAL WORKING GROUP</b>  <b>TECHNICAL SPECS CONTROLLED</b>  BY: <i>[Signature]</i>  DATE: <u>6/13/23</u></p>					
<p align="center">10:05  JUN 09 2023  <i>[Stamp]</i></p>					
<p>Charge to: Improvement of Farm to Market Road (FMR)  Laperas, Sulop, Davao del Sur  CY 2023 LOCAL GOVERNMENT DEVELOPMENT FUND (LGDF) - 20% DEVELOPMENT FUND</p>					
<p>Purpose/Remarks For use in the <b>IMPROVEMENT OF FARM TO MARKET ROAD (FMR)</b> located at <b>LAPERAS, SULOP, DAVAO DEL SUR</b></p>					
<p align="center"><i>[Signature]</i></p>					
<p align="center">CASH AVAILABILITY</p>					
<p align="center">APPROVED :</p>					
<p>Signature : <i>[Signature]</i></p>					
<p>Printed Name : <b>ANGELIE R. GELLA</b></p>					
<p>Designation : <b>PGADH-Assst. Prov'l. Engineer</b>  <b>OIC-Provincial Engineer</b>  (As Per Memo Order No. 22-2023)</p>					
<p>Date : June 8, 2023</p>					

*[Signature]*  
**YVONNE ROÑA CAGAS**  
Governor  
PROVINCE OF DAVAO DEL SUR

A 1407  
**CHRISTOPHER T. TAN**  
THERMORMO

## Statement of all On-going Government & Private Contracts including Contracts awarded but not yet started

Name of Project / Contact : \_\_\_\_\_

IB No. \_\_\_\_\_

Location: \_\_\_\_\_

Name of Contract / Location	a)Owner's Name b)Address c)Telephone No.	Nature of Work	Bidder's Role		a) Amount at award b) Duration	a)Date Awarded b)Date Started c)Target Completion Date	% of Accomplishment		Value of Outstanding Works/Undelivered Portion
			Description	%			Planned	Actual	
<b>Government</b>									
<b>Private</b>									
<b>Total Cost</b>									<b>P</b>

Note: This Statement shall be supported with:

1. Notice of Award and/or Contract
2. Notice to Proceed issued by the Procuring Entity
3. Certificate of Accomplishments signed by the owner or authorized representative

Submitted by : \_\_\_\_\_  
(Printed Name & Signature)

Designation : \_\_\_\_\_

Date : \_\_\_\_\_

## Statement of Single Largest Completed Contract (SLCC)

(Similar in Nature for the Last 3 years)

Name of Project/Contract: \_\_\_\_\_

IB No. \_\_\_\_\_

Location: \_\_\_\_\_

Name of Contract / Location Project Cost	a) Owner's Name b) Address c) Telephone No.	Nature of Work	Bidder's Role		a) Amount at Award b) Amount at Completion c) Duration	a) Date Awarded b) Date Started c) Date of Completion
			Description	%		

Note: This statement shall be supported with:

1. Contract/Purchase Order
2. Certificate of Completion/Acceptance or Inspection and Acceptance Report or Official Receipts

Submitted by: \_\_\_\_\_  
(Printed Name & Signature)

Designation: \_\_\_\_\_

Date: \_\_\_\_\_

## **Bid Securing Declaration Form**

*[shall be submitted with the Bid if bidder opts to provide this form of bid security]*

---

REPUBLIC OF THE PHILIPPINES)  
CITY OF \_\_\_\_\_ ) S.S.

**BID SECURING DECLARATION**  
**Project Identification No.: [Insert number]**

To: *[Insert name and address of the Procuring Entity]*

I/We, the undersigned, declare that:

1. I/We understand that, according to your conditions, bids must be supported by a Bid Security, which may be in the form of a Bid Securing Declaration.
2. I/We accept that: (a) I/we will be automatically disqualified from bidding for any procurement contract with any procuring entity for a period of two (2) years upon receipt of your Blacklisting Order; and, (b) I/we will pay the applicable fine provided under Section 6 of the Guidelines on the Use of Bid Securing Declaration, within fifteen (15) days from receipt of the written demand by the procuring entity for the commission of acts resulting to the enforcement of the bid securing declaration under Sections 23.1(b), 34.2, 40.1 and 69.1, except 69.1(f), of the IRR of RA No. 9184; without prejudice to other legal action the government may undertake.
3. I/We understand that this Bid Securing Declaration shall cease to be valid on the following circumstances:
  - a. Upon expiration of the bid validity period, or any extension thereof pursuant to your request;
  - b. I am/we are declared ineligible or post-disqualified upon receipt of your notice to such effect, and (i) I/we failed to timely file a request for reconsideration or (ii) I/we filed a waiver to avail of said right; and
  - c. I am/we are declared the bidder with the Lowest Calculated Responsive Bid, and I/we have furnished the performance security and signed the Contract.

IN WITNESS WHEREOF, I/We have hereunto set my/our hand/s this \_\_\_\_ day of *[month]* *[year]* at *[place of execution]*.

*[Insert NAME OF BIDDER OR ITS AUTHORIZED  
REPRESENTATIVE]*  
*[Insert signatory's legal capacity]*  
Affiant

**[Jurat]**  
*[Format shall be based on the latest Rules on Notarial Practice]*



## Omnibus Sworn Statement (Revised)

*[shall be submitted with the Bid]*

---

REPUBLIC OF THE PHILIPPINES )  
CITY/MUNICIPALITY OF \_\_\_\_\_ ) S.S.

### AFFIDAVIT

I, [Name of Affiant], of legal age, [Civil Status], [Nationality], and residing at [Address of Affiant], after having been duly sworn in accordance with law, do hereby depose and state that:

1. *[Select one, delete the other:]*

*[If a sole proprietorship:]* I am the sole proprietor or authorized representative of [Name of Bidder] with office address at [address of Bidder];

*[If a partnership, corporation, cooperative, or joint venture:]* I am the duly authorized and designated representative of [Name of Bidder] with office address at [address of Bidder];

2. *[Select one, delete the other:]*

*[If a sole proprietorship:]* As the owner and sole proprietor, or authorized representative of [Name of Bidder], I have full power and authority to do, execute and perform any and all acts necessary to participate, submit the bid, and to sign and execute the ensuing contract for [Name of the Project] of the [Name of the Procuring Entity], as shown in the attached duly notarized Special Power of Attorney;

*[If a partnership, corporation, cooperative, or joint venture:]* I am granted full power and authority to do, execute and perform any and all acts necessary to participate, submit the bid, and to sign and execute the ensuing contract for [Name of the Project] of the [Name of the Procuring Entity], as shown in the attached [state title of attached document showing proof of authorization (e.g., duly notarized Secretary's Certificate, Board/Partnership Resolution, or Special Power of Attorney, whichever is applicable)];

3. [Name of Bidder] is not "blacklisted" or barred from bidding by the Government of the Philippines or any of its agencies, offices, corporations, or Local Government Units, foreign government/foreign or international financing institution whose blacklisting rules have been recognized by the Government Procurement Policy Board, by itself or by relation, membership, association, affiliation, or controlling interest with another blacklisted person or entity as defined and provided for in the Uniform Guidelines on Blacklisting;

4. Each of the documents submitted in satisfaction of the bidding requirements is an authentic copy of the original, complete, and all statements and information provided therein are true and correct;

5. [Name of Bidder] is authorizing the Head of the Procuring Entity or its duly authorized representative(s) to verify all the documents submitted;

6. *[Select one, delete the rest:]*

*[If a sole proprietorship:]* The owner or sole proprietor is not related to the Head of the Procuring Entity, members of the Bids and Awards Committee (BAC), the Technical

Working Group, and the BAC Secretariat, the head of the Project Management Office or the end-user unit, and the project consultants by consanguinity or affinity up to the third civil degree;

*[If a partnership or cooperative.]* None of the officers and members of *[Name of Bidder]* is related to the Head of the Procuring Entity, members of the Bids and Awards Committee (BAC), the Technical Working Group, and the BAC Secretariat, the head of the Project Management Office or the end-user unit, and the project consultants by consanguinity or affinity up to the third civil degree;

*[If a corporation or joint venture.]* None of the officers, directors, and controlling stockholders of *[Name of Bidder]* is related to the Head of the Procuring Entity, members of the Bids and Awards Committee (BAC), the Technical Working Group, and the BAC Secretariat, the head of the Project Management Office or the end-user unit, and the project consultants by consanguinity or affinity up to the third civil degree;

7. *[Name of Bidder]* complies with existing labor laws and standards; and
8. *[Name of Bidder]* is aware of and has undertaken the responsibilities as a Bidder in compliance with the Philippine Bidding Documents, which includes:
  - a. Carefully examining all of the Bidding Documents;
  - b. Acknowledging all conditions, local or otherwise, affecting the implementation of the Contract;
  - c. Making an estimate of the facilities available and needed for the contract to be bid, if any; and
  - d. Inquiring or securing Supplemental/Bid Bulletin(s) issued for the *[Name of the Project]*.
9. *[Name of Bidder]* did not give or pay directly or indirectly, any commission, amount, fee, or any form of consideration, pecuniary or otherwise, to any person or official, personnel or representative of the government in relation to any procurement project or activity.
10. In case advance payment was made or given, failure to perform or deliver any of the obligations and undertakings in the contract shall be sufficient grounds to constitute criminal liability for Swindling (Estafa) or the commission of fraud with unfaithfulness or abuse of confidence through misappropriating or converting any payment received by a person or entity under an obligation involving the duty to deliver certain goods or services, to the prejudice of the public and the government of the Philippines pursuant to Article 315 of Act No. 3815 s. 1930, as amended, or the Revised Penal Code.

IN WITNESS WHEREOF, I have hereunto set my hand this \_\_\_ day of \_\_\_, 20\_\_ at \_\_\_\_\_, Philippines.

*[Insert NAME OF BIDDER OR ITS AUTHORIZED REPRESENTATIVE]*  
*[Insert signatory's legal capacity]*  
Affiant

**[Jurat]**  
*[Format shall be based on the latest Rules on Notarial Practice]*

**Bid Form for the Procurement of Infrastructure Projects**  
*[shall be submitted with the Bid]*

---

**BID FORM**

Project Identification No. : \_\_\_\_\_ Date : \_\_\_\_\_

To: *[name and address of Procuring Entity]*

Having examined the Philippine Bidding Documents (PBDs) including the Supplemental or Bid Bulletin Numbers *[insert numbers]*, the receipt of which is hereby duly acknowledged, we, the undersigned, declare that:

- a. We have no reservation to the PBDs, including the Supplemental or Bid Bulletins, for the Procurement Project: *[insert name of contract]*;
- b. We offer to execute the Works for this Contract in accordance with the PBDs;
- c. The total price of our Bid in words and figures, excluding any discounts offered below is: *[insert information]*;
- d. The discounts offered and the methodology for their application are: *[insert information]*;
- e. The total bid price includes the cost of all taxes, such as, but not limited to: *[specify the applicable taxes, e.g. (i) value added tax (VAT), (ii) income tax, (iii) local taxes, and (iv) other fiscal levies and duties]*, which are itemized herein and reflected in the detailed estimates,
- f. Our Bid shall be valid within the a period stated in the PBDs, and it shall remain binding upon us at any time before the expiration of that period;
- g. If our Bid is accepted, we commit to obtain a Performance Security in the amount of *[insert percentage amount]* percent of the Contract Price for the due performance of the Contract, or a Performance Securing Declaration in lieu of the allowable forms of Performance Security, subject to the terms and conditions of issued GPPB guidelines<sup>1</sup> for this purpose;
- h. We are not participating, as Bidders, in more than one Bid in this bidding process, other than alternative offers in accordance with the Bidding Documents;
- i. We understand that this Bid, together with your written acceptance thereof included in your notification of award, shall constitute a binding contract between us, until a formal Contract is prepared and executed; and
- j. We understand that you are not bound to accept the Lowest Calculated Bid or any other Bid that you may receive.
- k. We likewise certify/confirm that the undersigned, is the duly authorized

---

<sup>1</sup> currently based on GPPB Resolution No. 09-2020

representative of the bidder, and granted full power and authority to do, execute and perform any and all acts necessary to participate, submit the bid, and to sign and execute the ensuing contract for the [Name of Project] of the [Name of the Procuring Entity].

- I. We acknowledge that failure to sign each and every page of this Bid Form, including the Bill of Quantities, shall be a ground for the rejection of our bid.

Name: \_\_\_\_\_

Legal Capacity: \_\_\_\_\_

Signature: \_\_\_\_\_

Duly authorized to sign the Bid for and behalf of: \_\_\_\_\_

Date: \_\_\_\_\_



Republic of the Philippines  
PROVINCE OF DAVAO DEL SUR

Barangay Matti, Digos City, Davao del Sur

Mobile Nos: 0905-399-0526/0908-332-2024/0948-768-5848

Telefax: (082) 553-3579/ Website: www.davaodelsur.gov.ph

Email Add.: bac.davaodelsur2@gmail.com, sbacdavaodelsur@gmail.com

**OFFICE OF THE GOVERNOR**  
**BIDS AND AWARDS COMMITTEE (BAC)**

**Resolution No. 047**  
**Series of 2022**

**A RESOLUTION  
RECOMMENDING TO THE HEAD OF THE PROCURING ENTITY, GOVERNOR YVONNE  
ROÑA CAGAS TO ADOPT THE 3-STRIKE POLICY IN THE PROCUREMENT OF CONTRACTS  
FOR GOODS AND SERVICES, AND INFRASTRUCTURE PROJECTS OF THE PROVINCIAL  
GOVERNMENT OF DAVAO DEL SUR.**

**WHEREAS**, the Provincial Government of Davao del Sur encounters several failures of biddings due to constant errors committed by the participating Bidders in the submission of their bidding documents despite of the orientation during Pre-bid Conference and the Instruction to Bidders;

**WHEREAS**, to further strengthen the integrity of the competitive bidding process, the Bids and Awards Committee together with the Members of the Technical Working Group unanimously agreed that the following instructions are hereby issued pertaining to the implementation of the 3-Strike Policy of the Provincial Government of Davao del Sur against violations of Section 69 of the IRR of RA 9184;

1. The provision of Section 69.1 of the said IRR, pertaining to the 3-Strike Policy of the Provincial Government of Davao del Sur, is hereby reiterated as follows:  
*"In addition to the provisions of Rules XXI and XXII of this IRR, the Head of the Procuring Entity, subject to the authority delegated to the BAC, if any, shall impose on bidders or prospective bidders, the administrative penalty of suspension for one (1) year for the first offense, and suspension of two (2) years for the second offense from participating in the competitive bidding process, as well as disqualification from further participating in the competitive bidding being undertaken by the Procuring Entity concerned, where applicable, for the following violations: 69.1.i All other acts that tend to defeat the purpose of the competitive bidding, such as habitually withdrawing from bidding, submitting late Bids or patently insufficient bid, for at least three (3) times within a year, except for valid reasons."*
2. The violations enumerated, which are considered as acts that tend to defeat the purpose of competitive bidding, are hereby clarified to read as follows:
  - 2.a A Bidder that had purchased bidding documents, but subsequently (a) withdrawn from the bidding or (b) submitted a letter of non-participation, or (c) did not submit a bid -- without a valid cause, as determined by the Bids and Awards Committee (BAC);
  - 2.b Submission of erroneous, insufficient, defective documents such as, but not limited to, insufficient bid securities, any computational/typographical error in the submitted bidding documents and other deficiencies which causes bid disqualifications;
  - 2.c Non-submission of post-qualification and other requirements within the prescribed period as specified in the notice issued by the BAC;



Republic of the Philippines  
**PROVINCE OF DAVAO DEL SUR**  
Barangay Matti, Digos City, Davao del Sur  
Mobile Nos: 0905-299-0526/0908-332-2024/0948-768-5848  
Telefax: (082) 531-9579/ Website: www.davaodelsur.gov.ph  
Email Add.: bac.davaodelsur2@gmail.com, sbacdavaodelsur@gmail.com

**OFFICE OF THE GOVERNOR**  
**BIDS AND AWARDS COMMITTEE (BAC)**

BAC Resolution No. 047 s. 2022

Page -2-

x-x-x-x-x-x-x-x-x-x-x-x-x-x-x-x

3. Every time a bidder is observed to have done any of the three acts enumerated in Item 2 of paragraph a, b & c of this Resolution, the Chairperson of the BAC shall immediately serve a written notice to the bidder informing him of his act, and giving him three (3) calendar days to show cause why he should not be sanctioned committing an act which tends to defeat the purpose of public bidding under the 3-Strike Policy of the Provincial Government of Davao del Sur;
4. Based on the evaluation by the BAC of the bidder's response to the show cause notice mentioned in Item No. 3 of this Resolution, the BAC shall, within five (5) calendar days from the receipt of the bidder's response determine whether the bidder's act was done with or without a valid cause;
5. The BAC Secretariat shall submit to the BAC a 3-Strike Policy Report, which shall contain the information in item 3 and 9 of this Resolution. The Report must be received by the BAC through the Chairperson within fifteen (15) days after the date of the opening of bids;
6. The BAC through its Secretariat shall monitor the participation of bidders in all of its projects and maintain a tally of violations by each bidder of the 3-Strike Policy in its jurisdiction as well as of the violations by the bidder of the said policy in other offices of the Provincial Government of Davao del Sur;
7. For the procurement of Infrastructure Projects, this Policy is applicable to all modes of procurement, be it Competitive Bidding or alternative modes of procurement, however, for the procurement of Goods and Consulting Services, this Policy is applicable to Competitive Bidding only;
8. For the sanctions to be imposed:
  - **ONE (1) STRIKE** will be imposed for various IB Nos. participated by the bidder with the same nature of violation opened on the same date, or was disqualified during post-qualification stage with the same case of the latter;
  - **MULTIPLE STRIKES** for different discrepancies/offenses under different IB Nos. opened on the same date, or was disqualified during post-qualification stage with the same case of the latter;
9. Each "offense" by a bidder referred to in Section 69.1.i. of the IRR, as stated in this Resolution, consists of three violations or strikes within a period of one calendar year for all procurements by all offices of the Provincial Government of Davao del Sur. A Fresh Period of one (1) year in counting of "strikes" shall be observed in the succeeding year;
10. Based on the 3-Strike reports, the Bids and Awards Committee, shall recommend to the Head of the Procuring Entity, for approval, the following administrative sanctions on the erring Contractor/Supplier for the violation of the 3-Strike Policy:
  - a. For the first violation or strike – a first warning.
  - b. For the second strike – a second warning.
  - c. For the third strike, which together with the first two strikes constitutes the first offense against the 3-Strike Policy – an administrative penalty of suspension for one (1) year from participating in any procurement process in the Provincial Government of Davao del Sur.

**1 LOVE DAVAO DELSUR**



Republic of the Philippines  
**PROVINCE OF DAVAO DEL SUR**  
Barangay Matti, Digos City, Davao del Sur  
Mobile Nos: 0910: -299-0526/0908-332-2024/0948-768-5848  
Telefax: (082) 551-9579/ Website: www.davaodelsur.gov.ph  
Email Add.: bac.davaodelsur2@gmail.com, sbacdavaodelsur@gmail.com

**OFFICE OF THE GOVERNOR**  
**BIDS AND AWARDS COMMITTEE (BAC)**

BAC Resolution No. 047 s. 2022

Page -3-

x-x-x-x-x-x-x-x-x-x-x-x-x-x-x-x-x-x-x

- d. For the second offense – the second set of three strikes committed by the bidder – an administrative suspension for two (2) years from participating in any procurement process in the Provincial Government of Davao del Sur.

**WHEREFORE**, on motion of BAC Member Milana, duly seconded by BAC Member Putong, it was –

**RESOLVED**, as it is hereby **RESOLVED**, to recommend to the Head of the Procuring Entity, **YVONNE ROÑA CAGAS** to **ADOPT THE 3-STRIKE POLICY IN THE PROCUREMENT OF CONTRACTS OF THE PROVINCIAL GOVERNMENT OF DAVAO DEL SUR.**

**RESOLVED FINALLY**, to furnish copies of this Resolution to all agencies concerned, Suppliers, and Concerned End Users, for their information and guidance.

**UNANIMOUSLY APPROVED** at the Almendras Hall, Governor Douglas Ralota Cagas Sports and Business Complex, Barangay Matti, Digos City, Province of Davao del Sur, this 14<sup>th</sup> day of July, 2022.

I hereby certify the correctness of above-mentioned resolution.

  
**NORJANNA M. CAMAGUIN, MPA**  
LTOO IV  
Head, BAC Secretariat (Goods and Consulting Services)

  
**Engr. SHIELA MAE ZAPANTA, MPA**  
Agricultural Technologist  
Head, BAC Secretariat (Infrastructure Projects)

Attested by:

  
**DOMINICO S. BUCOL JD**  
PGDH-Provincial Warden Office  
BAC Member

(on leave)  
**RAUL R. FUECONCILLO, MagDev**  
PGDH-Office of the Provincial Agriculturist  
BAC Member

  
**Engr. ANGELIE R. GELLA**  
APGDH-PEO  
BAC Member

  
**Engr. RODERICK R. MILANA, REA**  
PGDH-PASSO  
BAC Member

**1 2008 DAVAO DEL SUR**



Republic of the Philippines  
**PROVINCE OF DAVAO DEL SUR**  
 Barangay Matti, Digos City, Davao del Sur  
 Mobile Nos: 0905-299-0526/0908-332-2024/0948-768-5848  
 Telefax: (082) 555-9579/ Website: www.davaodelsur.gov.ph  
 Email Add.: bac.davaodelsur2@gmail.com, sbacdavaodelsur@gmail.com

**OFFICE OF THE GOVERNOR**  
**BIDS AND AWARDS COMMITTEE (BAC)**

BAC Resolution No. 037 s. 2022

Page -4-

x-x-x-x-x-x-x-x-x-x-x-x-x-x-x-x-x-x-x

  
**ALLAN C. PUITONG**  
 PGDH-PGSO  
 BAC Member

  
**RAUL D. RAUT, EnP, JD**  
 PGDH-PHRMO  
 BAC Vice Chairperson

  
**DESSAMIE BUAT-SANCHEZ, CPA, JD**  
 PGDH-PBO  
 BAC Chairperson – Presiding Officer

Approved by:

  
**YVONNE RONA CAGAS**  
 Governor  
 Head of Procuring Entity



H





Republic of the Philippines  
**PROVINCE OF DAVAO DEL SUR**  
 Barangay Matti, Digos City, Davao del Sur  
 Mobile Nos: 0968-295-0535/0908-352-2024/0968-708-5848  
 Telefax: (082) 553-9579/ Website: www.davaodelsur.gov.ph  
 Email Add.: bac.davaodelsur2@gmail.com, sibacdavaodelsur@gmail.com

**OFFICE OF THE GOVERNOR**  
**BIDS AND AWARDS COMMITTEE (BAC)**

**Resolution No. 052**  
**Series of 2022**

**A RESOLUTION**  
**RECOMMENDING TO THE HEAD OF THE PROCURING ENTITY, GOVERNOR**  
**YVONNE ROÑA CAGAS TO ADOPT THE SUSPENSION OF PARTICIPATING**  
**BIDDERS WHO WILL INCUR ANY OF THE VIOLATIONS STIPULATED IN SECTION**  
**41 OF THE 2016 REVISED IMPLEMENTING RULES AND REGULATIONS OF**  
**REPUBLIC ACT NO. 9184, OTHERWISE KNOWN AS THE GOVERNMENT**  
**PROCUREMENT REFORM ACT.**

**WHEREAS**, the Provincial Government of Davao del Sur encounters failures of biddings due to constant violations committed by the participating Bidders in the submission of their bidding documents despite of the orientation during Pre-bid Conference and the Instruction to Bidders;

**WHEREAS**, to further strengthen the integrity of the competitive bidding process, the Bids and Awards Committee together with the Members of the Technical Working Group unanimously agreed that the following instructions are hereby issued pertaining to the implementation of the Suspension of the Participating Bidders against violations of Section 41 of the Revised IRR of RA 9184;

1. The provision of Section 41 the Revised IRR of RA 9184 is hereby reiterated as follows:

*“Section 41. Reservation Clause. - The Head of the Agency reserves the right to reject any and all Bids, declare a failure of bidding, or not award the contract in the following situations:*

- a. If there is prima facie evidence of collusion between appropriate public officers or employees of the Procuring Entity, or between the BAC and any of the bidders, or if the collusion is between or among the bidders themselves, or between a bidder and a third party, including any act which restricts, suppresses or nullifies or tends to restrict, suppress or nullify competition;*
  - b. If the BAC is found to have failed in following the prescribed bidding procedures; or*
  - c. For any justifiable and reasonable ground where the award of the contract will not redound to the benefit of the government as defined in the IRR.”*
2. The violations enumerated, which are considered as acts that tend to defeat the purpose of competitive bidding, are hereby clarified to read as follows:
- 2.a . *If there is prima facie evidence of collusion between appropriate public officers or employees of the Procuring Entity*

2.b *If there is prima facie evidence of collusion between the BAC and any of the bidders;*





Republic of the Philippines  
PROVINCE OF DAVAO DEL SUR  
Barangay Matti, Digos City, Davao del Sur  
Mobile Nos: 0905-299-0526/0903-332-2024/0908-763-5848  
Telefax: (082) 553-9539/ Website: www.davaodelsur.gov.ph  
Email Add.: bac.davaodelsur@gmail.com, sime.davaodelsur@gmail.com

OFFICE OF THE GOVERNOR  
BIDS AND AWARDS COMMITTEE (BAC)

BAC Resolution No. 052 s. 2022

Page -2-

x-x-x-x-x-x-x-x-x-x-x-x-x-x-x-x

2.c If there is *prima facie* evidence of collusion between or among the bidders themselves, or between a bidder and a third party, including any act which restricts, suppresses or nullifies or tends to restrict, suppress or nullify competition;

3. The BAC through its Secretariat shall monitor the participation of bidders in all of its projects and maintain a tally of violations by each bidder in its jurisdiction as well as of the violations by the bidder of the said policy in other offices of the Provincial Government of Davao del Sur.
4. The Bids and Awards Committee, shall recommend to the Head of the Procuring Entity, for approval, the administrative sanction on the erring participating bidder/contractor for the violation Section 41 of RA 9184:
  - a. For the first violation – an administrative penalty of suspension for three (3) months from participating in any procurement process in the Provincial Government of Davao del Sur.
  - b. For the second violation – an administrative penalty of suspension for one (1) year from participating in any procurement process in the Provincial Government of Davao del Sur.
  - c. For the third offense- perpetual disqualification from participating in any procurement process in the Provincial Government of Davao del Sur.

**WHEREFORE**, on motion of BAC Member Milana, duly seconded by BAC Member Putong, it was –

**RESOLVED**, as it is hereby **RESOLVED**, to recommend to the Head of the Procuring Entity, **GOVERNOR YVONNE ROÑA CAGAS to ADOPT THE SUSPENSION OF PARTICIPATING BIDDERS WHO WILL INCUR ANY OF THE VIOLATIONS STIPULATED IN SECTION 41 OF THE 2016 REVISED IMPLEMENTING RULES AND REGULATIONS OF REPUBLIC ACT NO. 9184, OTHERWISE KNOWN AS THE GOVERNMENT PROCUREMENT REFORM ACT.**

**RESOLVED FINALLY**, to furnish copies of this Resolution to all agencies concerned for their information and guidance.

**UNANIMOUSLY APPROVED** at the Almendras Hall, Governor Douglas Ralota Cagas Sports and Business Complex, Barangay Matti, Digos City, Province of Davao del Sur, this 14th day of July, 2022.

I hereby certify the correctness of above-mentioned resolution.

**ENGR. SHEILA MAE ZAPANTA, MPA**  
Agricultural Technologist  
Head, BAC Secretariat (Infrastructure Projects)

**NORJANNA M. QAMAGUIN, MPA**  
LTOO IV  
Head, BAC Secretariat (Goods and Consulting Services)





Republic of the Philippines  
**PROVINCE OF DAVAO DEL SUR**  
 Barangay Matti, Digos City, Davao del Sur  
 Mobile Nos: 0905-295-0526/0908-332-2024/0948-758-5878  
 Telefax: (082) 553-9579/ Website: www.davaodelsur.gov.ph  
 Email Add.: bac.davodelsur2@gmail.com, sbacdavaodelsur@gmail.com

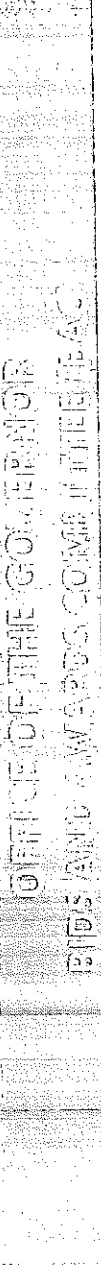

BAC Resolution No. 052.s. 2022

Page -3-

x-x-x-x-x-x-x-x-x-x-x-x-x-x-x-x

Attested by:

  
**DOMINIC S. BUCOL JD**  
 PGDH-Provincial Warden Office  
 BAC Member

(on leave)  
**RAUL R. FUECONCILLO, MagDev**  
 PGDH-OPAG  
 BAC Member

  
 Engr. **ANGELIE R. GELLA**  
 APGDH-PEO  
 BAC Member

  
 Engr. **RODERICK R. MILANA, REA**  
 PGDH-PASSO  
 BAC Member

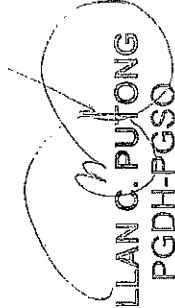
  
**ALLAN C. PUTONG**  
 PGDH-PGSO  
 BAC Member

  
**RAUL D. RAUT, EnP, JD**  
 PGDH-HRMO  
 BAC Vice Chairperson

  
**DESSAMIE BUAT-SANCHEZ, CPA, JD**  
 Provincial Budget Officer  
 BAC Chairperson – Presiding Officer

Approved by:

  
**YVONNE RONA CAGAS**  
 Governor  
 Head of Procuring Entity





Republic of the Philippines  
PROVINCE OF DAVAO DEL SUR

Barangay Matti, Digos City, Davao del Sur

Mobile No: 0998-299-4333/4334/4335 20240949 738-5648

Telefax: (082) 800-9011/11222 Website: www.davaodelsur.gov.ph

Email Add: bac.davaodelsur2@gmail.com, secretavaodelsur@gmail.com

OFFICE OF THE BAC SECRETARIAL  
Office Address: Digos City, Davao del Sur

Resolution No. 053  
Series of 2022

A RESOLUTION  
RECOMMENDING TO THE HEAD OF THE PROCURING ENTITY, GOVERNOR YVONNE ROÑA CAGAS, TO DECLARE BIDDERS WHO FAILED TO DISCLOSE ALL ON-GOING PROJECTS AS DISQUALIFIED, AFTER FINDING SUCH NON-INCLUSION DURING POST-QUALIFICATION OF BIDDERS BY THE BAC TECHNICAL WORKING GROUP (TWG).

Be it enacted by the BAC MEMBERS in meeting assembled:

WHEREAS, in line with the Provincial Government of Davao del Sur's initiative to fast-track the procurement transactions of the Province, the Special Bids and Awards Committee thereby adopts this Resolution to produce Contractors with integrity and truthfulness in their submitted bid;

WHEREAS, item number 2 of GPPB NPM 111-2013 states that, "*Failure to include all on-going and completed contracts in the Statement may be a ground for disqualification for being incomplete, and may also result in blacklisting if proven that such failure amounts to submission of false information or false documents. The submission of the eligibility documents enumerated in Section 23.1 of the IRR is a mandatory requirement that must be complied with by prospective bidders, such that failure to submit any of the documents or the submission of an otherwise incomplete or patently insufficient document, will disqualify the bidder based on the non-discretionary "pass/fail" criterion under Section 30.1 of the IRR.*"

IN ADDITION, GPPB NPM 006-2018 states that, "*Failure to declare an on-going government and private contract, including contracts awarded but not yet started, if any, whether similar or not similar in nature and complexity to the contract to be bid is a ground for disqualification. These contracts, as reflected in the "Statement of all on-going contracts", are vital to the computation of the Net Financial Contracting Capacity of the bidder, and they are necessary information during the post-qualification stage to verify, validate and ascertain the technical qualification of the Lowest Calculated Bidder for the ultimate determination whether it is the Lowest Calculated and Responsive Bidder.*"

WHEREFORE, after thorough deliberation, BAC Member Milana duly seconded by BAC Member Putong, it was-

RESOLVED, as it is hereby RESOLVED, to recommend to the HEAD OF PROCURING ENTITY, GOVERNOR YVONNE ROÑA CAGAS, TO DECLARE BIDDERS WHO FAILED TO DISCLOSE ALL ON-GOING PROJECTS AS DISQUALIFIED AFTER FINDING SUCH NON-INCLUSION DURING POST-QUALIFICATION OF BIDDERS BY THE BAC TECHNICAL WORKING GROUP (TWG);

RESOLVED FINALLY, to furnish copies of this Resolution to all agencies concerned for their information and guidance.

UNANIMOUSLY APPROVED at the Almendras Hall, Governor Douglas Ralota Cagas Sports and Business Complex, Barangay Matti, Digos City, Province of Davao del Sur, this 14th day of July, 2022.

I hereby certify to the correctness of above-mentioned resolution

  
Engr. SHIELA MAE ZAPANTA, MPA  
Agricultural Technologist

Head, BAC Secretariat (Infrastructure Projects)

  
NORJANNA M. CAMAGUIN, MPA  
LTOO IV

Head, BAC Secretariat (Goods and Consulting Services)

Attested by:

  
**DOMINIC S. BUCOL, JD**  
PGDH-P Provincial Warden Office  
BAC Member

*(on leave)*  
**RAUL R. FUECONCILLO, MagDev**  
PGDH-Office of the Provincial Agriculturist  
BAC Member

  
**Engr. ANGELIE R. GELLA**  
APGDH-PEO  
BAC Member

  
**Engr. RODERICK R. MILANA, REA**  
PGDH-PASSO  
BAC Member

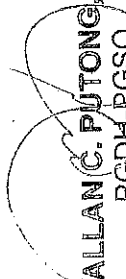
  
**ALLAN C. PUJONG, JD**  
PGDH-PGSO  
BAC Member

  
**RAUL D. RAUT, EnP, JD**  
PGDH-HRMO  
BAC Vice Chairperson

  
**DESSAMIE BUAT-SANCHEZ, CPA, JD**  
PGDH - PBO  
BAC Chairperson – Presiding Officer

Approved by:

  
**YVONNE RINA GAGAS**  
Governor  
Head of Procuring Entity



REPUBLIC OF THE PHILIPPINES  
 PROVINCE OF DAVAO DEL SUR  
 Office of the Governor

# PROCUREMENT MANAGEMENT OFFICE BIDS AND AWARDS COMMITTEE

Mobile Nos. 0905-229-0526/0908-332-2024 (Goods), 0948-768-5848 (Infra)  
 Telefax: (082) 553-9579

Website: [www.davaodelsur.gov.ph/pgco-bac](http://www.davaodelsur.gov.ph/pgco-bac)

Email Add.: [bac.davaodelsur2@gmail.com](mailto:bac.davaodelsur2@gmail.com)/[sbaedcavodelsur@gmail.com](mailto:sbaedcavodelsur@gmail.com)

*9000 Davao del Sur*

## TWG – CHECKLIST FOR BID EVALUATION

IB No.	Name of Project:	FINDINGS	REMARKS
	<b>Contractor:</b>		
	<b>ITEMS:</b>		
	1. Bid Amount (both in words and in figure) must be below ABC.		
	2. Bill of Quantities submitted by the contractor must conform with the Bill of Quantities issued by the End-User.		
	3. Detailed Estimates		
	A. Check mathematical computation in the Detailed Estimates		
	B. The amount in the Detailed Estimates must be reconciled with the amount in the summary of bid and the quantities in the BOQ.		
	C. Allowance for waste and/or losses, not to exceed 5% of materials equipment.		
	D. Mobilization and demobilization shall not exceed 1% of the Estimated Direct Cost EDC) of the civil works items.		
	E. Overhead expenses must be within the range of %-11% of the EDC.		
	F. Contingencies must be within the range of 0.5%-3% of the EDC.		
	G. Miscellaneous expenses must be within the range of 0.5%-1% of the EDC.		
	H. Contractor's Profit Margin shall be 8% of the EDC for projects above 5 million and <b>10% for the projects 5 million and below.</b>		
	I. VAT Component shall be 5% of the sum of the EDC, OCM, and Profit.		
	J. The following non-civil work items shall not be subjected to OCM mark-up:		
	1. Field/ Laboratory Office & Living Quarters (Rental Basis)		
	2. Furnishing of Furniture, Laboratory Equipment, Survey Equipment and Consumables		
	3. Assistance to the Engineers		
	4. Photographs		
	5. <b>Health and Safety</b>		
	2. Traffic Management		
	3. Environmental Compliance		
	4. Communication Equipment		
	5. <b>Project Billboard, etc.</b>		

P  
M  
O



# PROCUREMENT MANAGEMENT OFFICE BIDS AND AWARDS COMMITTEE

Mobile Nos. 0905-229-0526/0908-332-2024 (Goods), 0948-768-8848 (Infra)

Telefax: (082) 553-9579

Website: [www.davaodelsur.gov.ph/pgo-bac](http://www.davaodelsur.gov.ph/pgo-bac)

Email Add.: [bac.davaodelsur2@gmail.com](mailto:bac.davaodelsur2@gmail.com)/[sbaadavaodelsur@gmail.com](mailto:sbaadavaodelsur@gmail.com)

*I Love Davao del Sur*

K. The following items shall not be subjected to OCM and Profit mark-up:		
<b>A. Mobilization and demobilization</b>		
<b>B. Provision of Service Vehicle</b>		
<b>C. Permits and Clearances</b>		
<b>4. Bid Security</b>		
<b>A. Cash or Cashier's/ Manager's check (2%)</b>		
<b>B. Bank Guarantee/ Draft or Irrevocable Letter of Credit (2%)</b>		
<b>C. Surety Bond callable upon demand (5%)</b>		
<b>D. Bid Securing Declaration (must be in prescribed form, 15 days)</b>		
<b>E. Cash Flow by quarter and payment schedule (check mathematical computation against the bid amount)</b>		



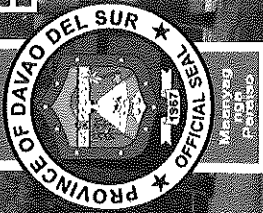

**PROCUREMENT MANAGEMENT OFFICE**  
**BIDS AND AWARDS COMMITTEE**

Mobile Nos. 0905-229-0526/0908-332-2024 (Goods), 0948-768-5848 (Infra)  
Telefax: (082) 553-9579  
Website: www.davaodelsur.gov.ph/pgo-bac  
Email Add: bac.davaodelsur2@gmail.com/sbacdavaodelsur@gmail.com

*Jose Davao del Sur*

**TWG – CHECKLIST FOR POST QUALIFICATION**

IB. No.	Name of Project:	FINDINGS	REMARKS
	<b>Contractor:</b>		
	<b>TECHNICAL DOCUMENTS:</b>		
	1. Not a Blacklisted Contractor per GPPB Website		
	2. Registration certificate from SEC, Department of Trade and Industry (DTI) for sole proprietorship, or CDA for cooperatives must be valid (Company Name and Validity)		
	3. Mayor's/ Business permit must be valid (Company Name and Validity)		
	4. Tax Clearance must be valid (Company Name and Validity)		
	5. PhilGEPS Registration (Platinum Membership) must be valid (Company Name and Validity)		
	6. Valid Philippine Contractors Accreditation Board or Special PCAB License in case of Joint Ventures (PCAB)		
	7. Statement of all on-going government and private contracts including awarded but not yet started		
	A. Complete attachments		
	I. Notice of Award		
	II. Contract		
	III. Notice to Proceed		
	IV. Contract Extension, if any;		
	V. Statement of Work Accomplishment duly signed by the Procuring Entity		
	B. Evaluate the projects, if any;		
	i. Verify Target Date of Completion		
	ii. Must not incur Negative Slippage of more than fifteen percent (15%) in any one project or a negative slippage of more than ten percent (10%) in each two (2) or more contracts.		
	C. Verification of on-going projects via DPWH portal		
	8. Statement of the bidder's Single Largest Completed Contract (SLCC) similar to the contract to be bid for the last (3) years, and whose value, adjusted to current prices using the PSA consumer price indices, must be at least fifty percent (50%) of the ABC to be bid; Provided, however, that contractors under Small A and Small B categories without similar experience on the contract to be bid may be allowed to bid if the cost of such contract is not more than the Allowable Range of Contract Cost (ARCC) of their registration based on the guidelines as prescribed by the PCAB.		
	Must be supported with the following:		
	A. Contract / Purchase Order		
	B. Certificate of Completion / Acceptance or Inspection Report or Official Receipt		
	C. Validate Contractors/Constructors Performance Evaluation System (CPES) in DPWH website.		



P  
M  
O



Makabayan  
Palais

Republic of the Philippines  
PROVINCE OF DAVAO DEL SUR  
Office of the Governor

# PROCUREMENT MANAGEMENT OFFICE BIDS AND AWARDS COMMITTEE

Mobile Nos. 0905-229-0526/0908-332-2024 (Goods), 0948-768-5848 (Infra)  
Telefax: (082) 553-9579

Website: [www.davaodelsur.gov.ph/pgco-bac](http://www.davaodelsur.gov.ph/pgco-bac)

Email Add: [bac.davaodelsur2@gmail.com](mailto:bac.davaodelsur2@gmail.com)/[sbacdavaodelsur@gmail.com](mailto:sbacdavaodelsur@gmail.com)

*9 Rays Davao del Sur*

9. Omnibus Sworn Statement must be in prescribed form (1 to 9) and duly notarized		
10. Net Financial Contracting Capacity (NFCC) must be reconciled with the Audited Financial Statements		
11. Income Tax Return as of 2020		
12. Business Tax Return Quarterly or Monthly as of 2021		
13. Construction Methods must conform with the approved plan		
14. Construction schedule and S-Curve must conform with the prescribed contract duration and the bid amount		
15. PERT-CPM must conform with the contract duration		
16. Manpower Utilization must conform with the POW		
17. Equipment Utilization must conform with the POW		
18. Duly Notarized Affidavit of Site Inspection		
19. Duly Notarized Compliance to Existing Labor Laws and Standards		



REPUBLIC OF THE PHILIPPINES  
PROVINCE OF DAVAO DEL SUR  
**PROVINCIAL ENGINEER'S OFFICE**  
SAN AGUSTIN, DIGOS CITY, DAVAO DEL SUR

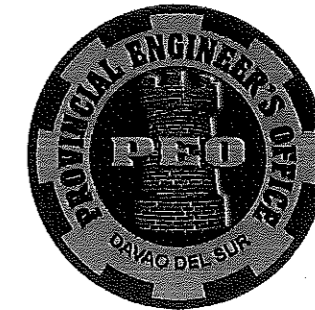

DETAILED ENGINEERING DESIGN

**IMPROVEMENT OF FARM TO MARKET ROAD (FMR)**  
LAPERAS, SULOP, DAVAO DEL SUR

**PROJECT LIMITS:**

BEGINNING OF PROJECT ----- STA. 0 + 000.00  
END OF PROJECT ----- STA. 0 + 175.50  
TOTAL LENGTH ----- 175.50 meters

SUBMITTED:

  
**JOSEPH R. GONZALES**  
ENGINEER II  
Planning and Programming Division Head

RECOMMENDING APPROVAL:

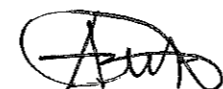
  
**ANGELIE R. GELLA**  
PGADH - Assistant Provincial Engineer  
OIC - Provincial Engineer  
(As per Memo. Order No. 22-2023)

APPROVED:

  
**YVONNE RONA CAGAS**  
Provincial Governor



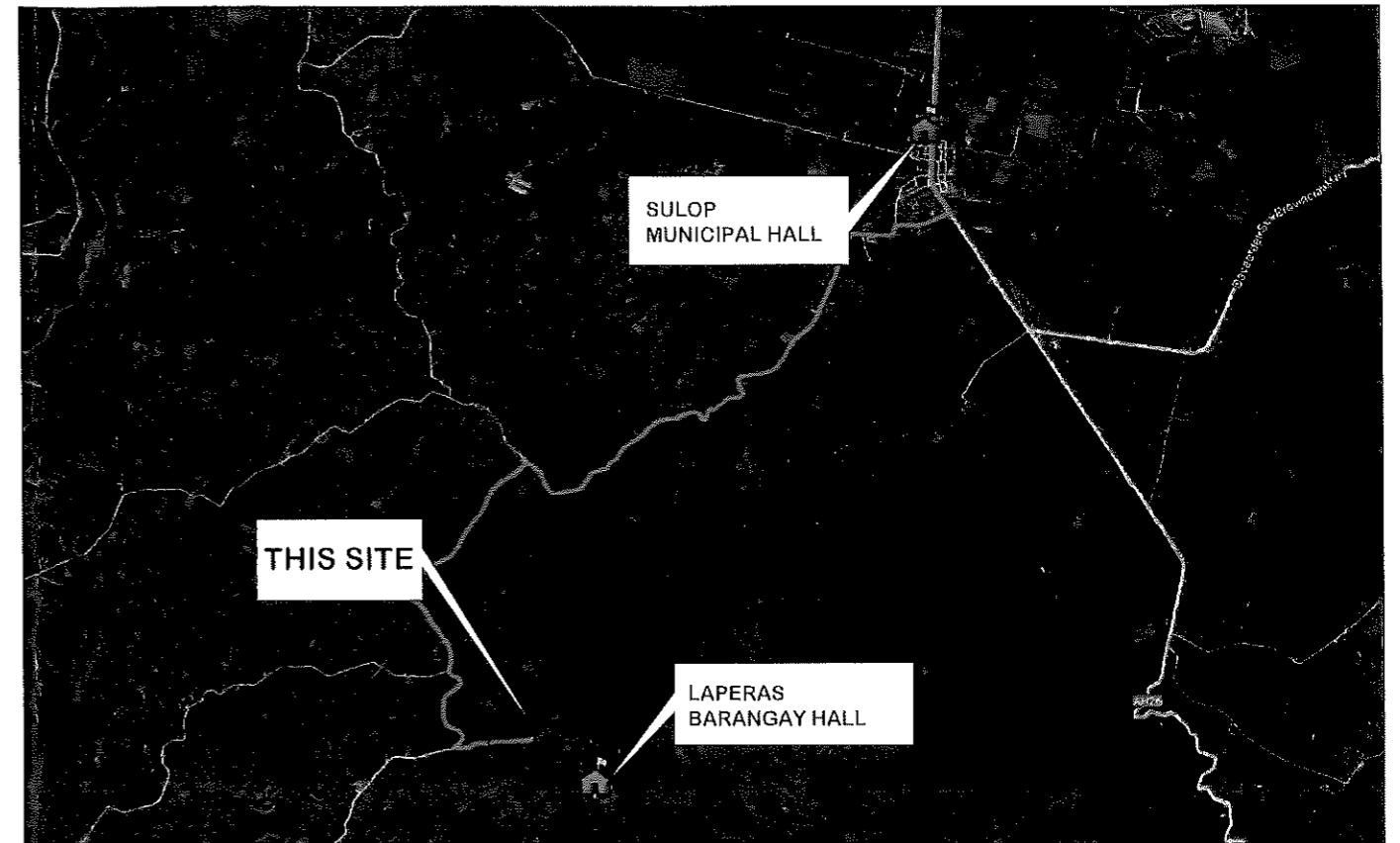
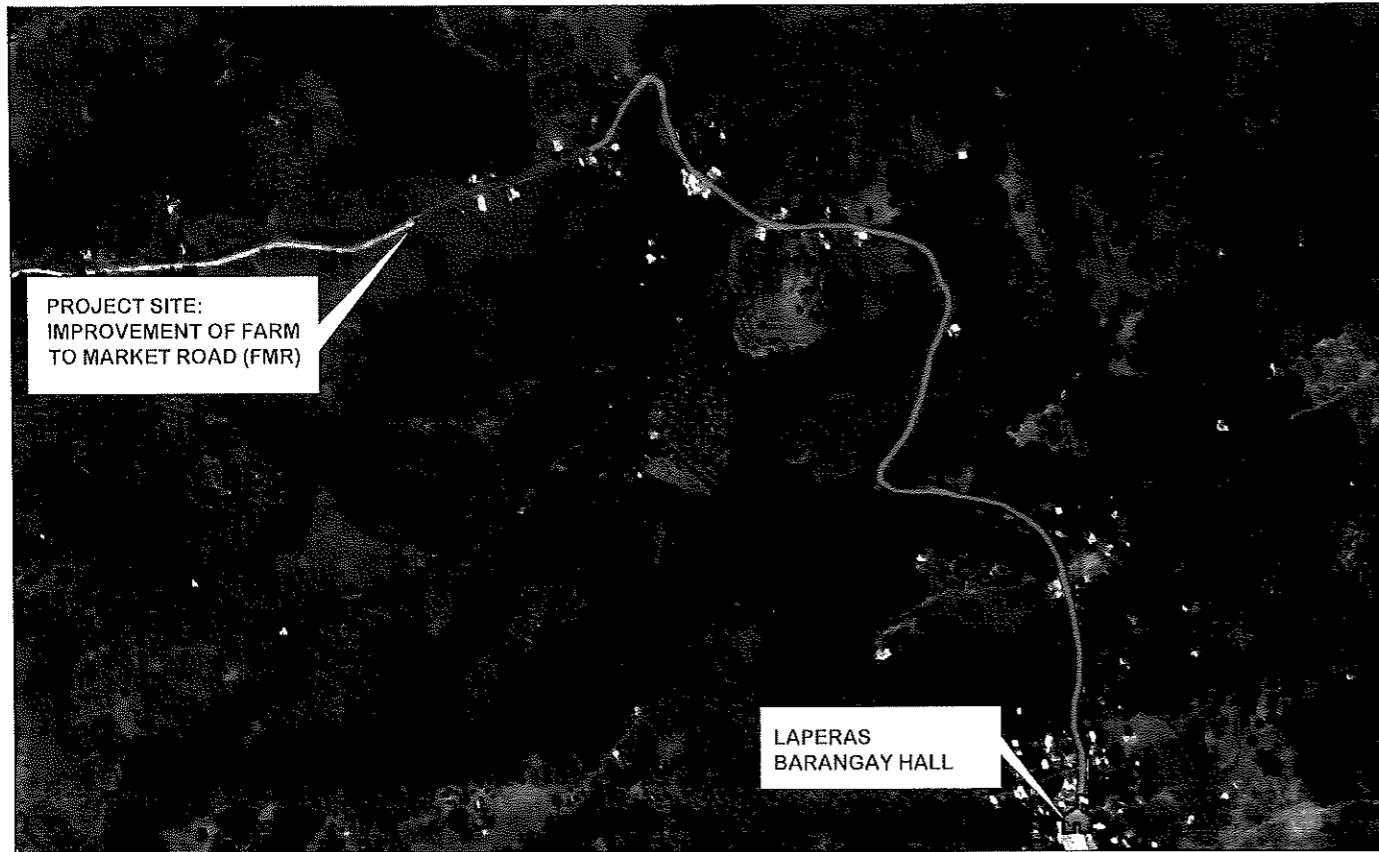

# TABLE OF CONTENTS

TABLE OF CONTENTS	-----	1
LOCATION PLAN & VICINITY MAP	-----	2
GENERAL NOTES	-----	3
PROJECT BILLBOARD & SUMMARY OF QUANTITIES	-----	4
GENERAL PLAN	-----	5
TYPICAL ROADWAY SECTION & PAVEMENT DETAILS	-----	6 - 7
DESIGN PARAMETERS FOR PAVEMENT	-----	8 - 9
PLAN & PROFILE	-----	10
ROADWAY CROSS SECTIONS	-----	11

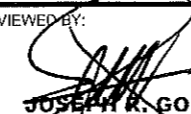
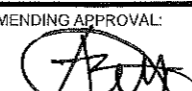

 **VICINITY MAP**

 **LOCATION MAP**

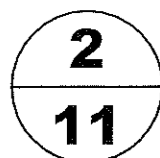
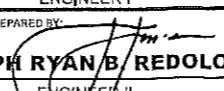
 <p>REPUBLIC OF THE PHILIPPINES  <b>PROVINCIAL ENGINEER'S OFFICE</b>          SAN AGUSTIN, DIGOS CITY, DAVAO DEL SUR</p>	PROJECT TITLE: <b>IMPROVEMENT OF FARM TO MARKET ROAD (FMR)</b>	SURVEYED BY:  <b>DONALD A. RELON</b> ENGINEER I	REVIEWED BY:  <b>JOSEPH R. GONZALES</b> ENGINEER II Planning and Programming Division Head	RECOMMENDING APPROVAL:  <b>ANGELIE R. GELLA</b> PGADH - Assistant Provincial Engineer OIC - Provincial Engineer (As per Memo, Order No. 22-2023)	APPROVED BY:  <b>YVONNE ROMA CAGAS</b> Provincial Governor	
	LOCATION: <b>LAPERAS, SULOP, DAVAO DEL SUR</b>	DESIGNED & PREPARED BY:  <b>JOSEPH RYAN B. REDOLOSO</b> ENGINEER II				

GENERAL NOTES

GENERAL REQUIREMENTS

1. THE CONTRACTOR SHALL PROVIDE AND MAINTAIN OFFICES, SHOPS, STORES, AND WORKMENS ACCOMMODATION AS ARE NECESSARY. A MEDICAL ROOM TOGETHER WITH ALL NECESSARY SUPPLIES SHALL ALSO BE PROVIDED AND MAINTAINED AND A TRAINED MEDICAL AIDE SHALL BE EMPLOYED SOLELY ON MEDICAL DUTIES.
2. TWO (2) PROJECT BILLBOARDS SHALL BE INSTALLED, ONE AT THE BEGINNING AND ONE AT THE END OF THE PROJECT. FOR ROAD PROJECTS WITH LENGTH OF 10 KILOMETERS OR MORE, ADDITIONAL BILLBOARD SHALL BE INSTALLED EVERY 5-KILOMETER INTERVAL.
3. BASIC PERSONAL PROTECTIVE EQUIPMENT (PPE) FOR ALL CONSTRUCTION WORKERS SHALL BE PROVIDED AND OTHER REQUIRED SPECIALTY PPE AS PER DD 13, S. 2018, SAFETY PERSONNEL AND EMERGENCY OCCUPATIONAL HEALTH PERSONNEL AND FACILITIES ARE REQUIRED DEPENDING ON THE NUMBER OF WORKERS.
4. TRAFFIC MANAGEMENT LAYOUTS PROVIDED IN THE PLAN MAY NOT NECESSARILY BE SIMILAR ON SITE. ADJUSTMENTS MAY BE MADE TO PROVIDE THE NECESSARY TRAFFIC CONTROL DEVICES TO BE INSTALLED ON SITE. A TRAFFIC CONTROLLER MUST ALSO BE PROVIDED ESPECIALLY WHEN CLOSING A CERTAIN LANE OF THE ROAD HINDERS THE CONTINUOUS TRAFFIC FLOW FOR A TWO-WAY TRAFFIC.
5. ADEQUATE BARRICADES AND TRAFFIC WARNING SIGNS SHALL BE INSTALLED AND WORKING AREA SHALL BE ADEQUATELY ILLUMINATED AT NIGHT TO WARN MOTORISTS OF ONGOING CONSTRUCTION. FLAGMEN SHALL BE PROVIDED AT EACH END OF THE CLOSED SECTION TO DIRECT COUNTER FLOW TRAFFIC.
6. THE AS-STAKED PLAN SHALL BE PREPARED BY THE CONTRACTOR BASED ON THE PRE-CONSTRUCTION SURVEY JOINTLY CONDUCTED BY THE CONTRACTOR AND IMPLEMENTING OFFICE (CONSTRUCTION AND PLANNING AND PROGRAMMING DIVISION).
7. ALL SURVEY, STAKING, RECORDING OF DATA, AND CALCULATIONS NECESSARY TO CONSTRUCT THE PROJECT FROM THE INITIAL LAYOUT TO FINAL COMPLETION SHALL BE PERFORMED. WORK SHALL BE STARTED AFTER STAKING FOR THE AFFECTED WORK IS ACCEPTED.
8. ANY EXISTING ROAD WHILE UNDERGOING IMPROVEMENT SHALL BE KEPT OPEN TO TRAFFIC CONTINUOUSLY IN SATISFACTORY CONDITION AND TRAFFIC SHALL BE ACCOMMODATED DURING THE ENTIRE CONTRACT PERIOD. CONSTRUCTING AND MAINTAINING DETOURS SHALL BE DONE AS LOCATED BY THE ENGINEER.

DESIGN WAS BASED ON SURVEY DATA SUBMITTED BY THE SURVEY UNIT OF PLANNING AND PROGRAMMING DIVISION OF THE PROVINCIAL ENGINEER'S OFFICE OF DAVAO DEL SUR

EARTHWORK

1. CLEARING SHALL EXTEND ONE (1) METER BEYOND THE TOE OF THE FILL SLOPES OR BEYOND ROUNDING OF CUT SLOPES FOR THE ENTIRE LENGTH OF THE PROJECT PROVIDED THAT IT IS WITHIN THE RIGHT-OF-WAY LIMITS OF THE PROJECT.
2. ALL CONCRETE PAVEMENT, BASE COURSE, SIDEWALKS, CURBS, GUTTERS, ETC. DESIGNATED FOR REMOVAL, SHALL BE BROKEN INTO PIECES, THE SIZE OF WHICH SHALL NOT EXCEED 300MM IN ANY DIMENSION AND STOCKPILED AT DESIGNATED LOCATIONS ON THE PROJECT FOR USE BY THE GOVERNMENT OTHERWISE DEMOLISHED AND DISPOSED OF AS DIRECTED BY THE ENGINEER.
3. EXCAVATION OPERATIONS SHALL BE CONDUCTED SO THAT MATERIAL OUTSIDE OF THE LIMITS OF SLOPES WILL NOT BE DISTURBED.
4. PRIOR TO CONSTRUCTION OF EMBANKMENT, ALL NECESSARY CLEARING AND GRUBBING IN THAT AREA SHALL HAVE BEEN PERFORMED IN CONFORMITY WITH ITEM 100, CLEARING AND GRUBBING.
5. ROADWAY EMBANKMENT OF EARTH MATERIALS SHALL BE PLACED IN HORIZONTAL LAYERS NOT EXCEEDING 200MM, LOOSE MEASUREMENT, AND SHALL BE COMPACTED AS SPECIFIED BEFORE THE NEXT LAYER IS PLACED. AS COMPACTION OF EACH LAYER PROGRESSES, CONTINUOUS LEVELING AND MANIPULATING WILL BE REQUIRED TO ASSURE UNIFORM DENSITY.
6. PRIOR TO FINAL ACCEPTANCE, THE INSPECTOR SHALL VISUALLY INSPECT THE ENTIRE SECTION OF THE COMPACTED EMBANKMENT. IF FOUND NOT UNIFORM OR THE TEST VALUES MAY NOT BE REPRESENTATIVE OF THE ENTIRE SECTION, ADDITIONAL TESTS MAY BE PERFORMED AND DEFICIENCIES SHALL BE CORRECTED BY THE CONTRACTOR.
7. ADEQUATE DUST CONTROL MUST BE MAINTAINED BY THE CONTRACTOR AT ALL TIMES DURING EARTH-MOVING OPERATIONS THROUGH THE USE OF WATER.
8. THE CONTRACTOR SHALL NOT PLACE STOCKPILES AT LOCATIONS WHERE THEY ARE SUBJECT TO EROSION. THE CONTRACTOR SHALL MAINTAIN EROSION AND DRAINAGE CONTROL NEAR ALL STOCKPILES AND SHALL ENSURE THAT SURFACE DRAINAGE DOES NOT ADVERSELY AFFECT ADJACENT LANDS, WATERCOURSES OR FUTURE RECLAMATION SITES.
9. STOCKPILES SHALL NOT BE SITUATED AT LOCATIONS THAT WILL INTERFERE OR CAUSE DAMAGE TO UTILITIES. IT SHALL NOT BE SITUATED WITHIN 30M OF A WATERCOURSE OR PERMANENT STRUCTURE OR WITHIN 4M OF ADJACENT PROPERTY BOUNDARY UNLESS OTHERWISE PERMITTED IN WRITING BY THE PROPERTY OWNER.

10. FINISHED SURFACES IN ALL CASES SHALL CONFORM WITH LINES, GRADES, DIMENSIONS AND ADJUSTMENTS SHOWN ON THE APPROVED PLANS, EXCEPT AS MODIFIED BY WRITTEN ORDERS.
11. CUT SLOPES, EXCEPT IN ROCKS AND FILL SLOPES SHALL BE ADJUSTED AND WARPED FLOW INTO EACH OTHER OR INTO NATURAL GROUND SURFACE WITHOUT NOTICEABLE BREAK.

SUB-BASE AND BASE COURSE

1. FOR SUBBASE MATERIALS, WHERE THE REQUIRED THICKNESS IS 200MM OR LESS, THE MATERIAL SHALL BE SPREAD AND COMPACTED IN ONE (1) LAYER USING A VIBRATORY ROLLER EQUIPMENT. WHERE THE REQUIRED THICKNESS IS MORE THAN 200MM, THE AGGREGATE SUBBASE SHALL BE SPREAD AND COMPACTED IN TWO OR MORE LAYERS OF APPROXIMATELY EQUAL THICKNESS, AND THE MAXIMUM COMPACTED THICKNESS OF ANY LAYER SHALL NOT EXCEED 200MM.

SURFACE COURSES

1. THE CONTRACTOR SHALL TAKE ALL STEPS NECESSARY TO CONTROL TRAFFIC OVER NEWLY-LAID BITUMINOUS SURFACE TREATMENT SO THAT THE SURFACE IS NOT DAMAGED IN ANY WAY. TRAFFIC SHALL BE PROHIBITED FROM TRAVELING AT SPEEDS IN EXCESS OF 40KPH UNTIL THE ASPHALTIC MATERIAL HAS SET. NO VEHICLES, INCLUDING THOSE DELIVERING AGGREGATES SHALL BE PERMITTED TO TURN AROUND ON NEWLY-LAID MATERIAL.
2. WHEN RAIN APPEARS IMMINENT, ALL PAVING OPERATIONS SHALL STOP.
3. AT TRANSVERSE CONSTRUCTION JOINTS SHALL BE DRILLED AT ONE-HALF (1/2) OF THE EXISTING CONCRETE PAVEMENT THICKNESS SO AS TO PERMIT THE LOAD TRANSFER DEVICE. USE 25mm DIA PLAIN BAR SPACED AT 150mm AND 130mm OR 28mm DIA. PLAIN BAR SPACED AT 190mm FOR (280mm and 300mm THK PCCP AS PER DD 40, S. 2014) TO BE INSERTED AT ONE-HALF (1/2) OF ITS LENGTH. THE SAID DEVICE SHALL BE INSTALLED FIRMLY AT THE HOLES AND SHALL BE HELD IN POSITION PARALLEL TO THE SURFACE OF THE SLAB. THE DOWEL BARS SHALL BE PAINTED WITH RED LEAD AND THE SURFACE OF (1/2) OF THE LENGTH TO BE INSERTED SHALL BE COATED WITH CONCRETE EPOXY WHILE THE OTHER HALF SHALL BE COATED WITH APPROVED BITUMINOUS MATERIALS.
4. IN ORDER THAT THE CONCRETE MAY BE PROPERLY PROTECTED AGAINST THE EFFECTS OF RAIN BEFORE THE CONCRETE IS SUFFICIENTLY HARDENED, THE CONTRACTOR WILL BE REQUIRED TO PROTECT THE EDGES AND SURFACE OF THE UNHARDENED CONCRETE.
5. BEFORE OPENING TO TRAFFIC, THE PAVEMENT SHALL BE CLEANED AND JOINT SEALING COMPLETED.
6. ANY DAMAGE TO THE PAVEMENT, OCCURRING PRIOR TO FINAL ACCEPTANCE, SHALL BE REPAIRED OR THE PAVEMENT BE REPLACED.
7. NO ACCEPTANCE AND FINAL PAYMENT SHALL BE MADE ON COMPLETED PAVEMENT UNLESS CORE TEST FOR THICKNESS DETERMINATION IS CONDUCTED.
8. PURSUANT TO DEPARTMENT ORDER NO. 137, SERIES OF 2016, FOR NEWLY CONSTRUCTED CONCRETE AND ASPHALT ROAD PROJECTS, AN IRI VALUE OF NOT MORE THAN 3.00M/KM IS PRESCRIBED. NON-COMPLIANCE WITH THE SAID DO SHALL BE SUBJECT TO PAY ADJUSTMENTS CORRESPONDING TO THE ACQUIRED IRI VALUE. COMPLIANCE OF THE CONTRACTORS TO THE IRI REQUIREMENT AND STRICT IMPLEMENTATION OF PROPER BASE AND SUBBASE PREPARATION IS EMPHASIZED PRIOR TO CONCRETE POURING, PREPARATORY WORKS IN EXISTING SURFACES/ROADBED PRIOR TO ASPHALT LAYING AND PAVING AND FINISHING FOR CONCRETE PAVEMENT.

DRAINAGE AND SLOPE PROTECTION STRUCTURES

1. PIPE CULVERTS SHALL BE INSPECTED BEFORE ANY BACKFILL IS PLACED. ANY PIPE FOUND TO BE OUT OF ALIGNMENT, UNDULY SETTLED, OR DAMAGED SHALL BE TAKEN UP AND RELAID OR REPLACED.
2. STONES FOR RIPRAP SHALL CONSIST OF ROCK AS NEARLY AS RECTANGULAR IN SECTION EXCEPT THAT RIPRAP OF CLASS A MAY CONSIST OF ROUND NATURAL STONES. SOUND PIECES OF BROKEN CONCRETE OBTAINED FROM THE REMOVAL OF BRIDGES, CULVERTS AND OTHER STRUCTURES MAY BE SUBSTITUTED FOR STONE WITH THE APPROVAL OF THE ENGINEER.
3. FOR STONE MASONRY, IT SHALL BE SATISFACTORILY PROTECTED FROM THE SUN AND KEPT WET FOR A PERIOD OF AT LEAST THREE DAYS AFTER COMPLETION.

MISCELLANEOUS STRUCTURES

1. OBSTRUCTIONS WITHIN THE ROADWAY, IF NOT ILLUMINATED, SHALL BE MARKED WITH REFLECTORIZED HAZARD MARKERS (REFER TO SECTION 7 OF THE HIGHWAY SAFETY DESIGN STANDARDS PART 2 MAY 2012 EDITION). FOR ADDITIONAL EMPHASIS, IT IS ADVISABLE TO MARK OBSTRUCTIONS WITH NO LESS THAN FIVE ALTERNATING REFLECTORIZED BLACK AND WHITE STRIPES.
2. NEWLY-COMPLETED CAST-IN-PLACE CURB AND GUTTER SHALL BE COVERED WITH SUITABLE MATERIAL AND KEPT MOIST FOR A PERIOD OF 3 DAYS. THE CONCRETE SHALL BE SUITABLY PROTECTED FROM THE WEATHER UNTIL THOROUGHLY HARDENED.
3. GUARDRAIL POSTS SHALL BE SET VERTICALLY IN THE POSITION SHOWN IN THE PLANS AND SHALL REMAIN UNDISTURBED FOR A MINIMUM OF 48 HOURS.
4. RAIL ELEMENTS SHALL BE ERECTED IN A MANNER RESULTING IN A SMOOTH CONTINUOUS INSTALLATION. ALL BOLTS, EXCEPT ADJUSTMENT BOLTS, SHALL BE DRAWN TIGHT.
5. PAVEMENT MARKINGS SHALL NOT BE APPLIED DURING RAIN OR WET WEATHER OR WHEN THE AIR IS MISTY. PAINT SHALL NOT BE APPLIED UPON DAMP PAVEMENT SURFACES, OR UPON PAVEMENT WHICH HAS ABSORBED HEAT SUFFICIENT TO CAUSE THE PAINT TO BLISTER AND PRODUCE A POROUS FILM OF PAINT.
6. PAVEMENT MARKINGS THAT FAIL TO HAVE A UNIFORM, SATISFACTORY APPEARANCE EITHER BY DAY OR NIGHT, SHALL BE CORRECTED BY THE CONTRACTOR AT NO COST TO THE GOVERNMENT.
7. TRAFFIC PAINT OF LANE MARKERS AND TRAFFIC STRIPS SHALL BE APPLIED TO THE PAVEMENT AT THE RATE OF 0.33 L/SQ.M. AND SHALL DRY SUFFICIENTLY TO BE FREE FROM CRACKING IN FROM 15 TO 30 MINUTES. THE AMOUNT OF GLASS BEADS TO BE MIXED WITH THE PAINT SHALL BE 500 GRAMS PER LITER OF PAINT.
8. JOINT SEALANT APPLICATION SHALL BE TAKEN CARE OF TO AVOID OVERFILLING OF THE JOINT SPACES. ANY EXCESS MATERIAL SHOULD BE IMMEDIATELY SCRAPPED FROM THE PAVEMENT SURFACE.
9. ROAD SIGNS SHALL USE A REFLECTIVE SHEETING CONSISTING OF SPHERICAL LENS ELEMENTS EMBEDDED WITHIN A TRANSPARENT PLASTIC HAVING A SMOOTH, FLAT SURFACE WITH A PROTECTED PRECAT ADHESIVE WHICH SHALL BE PRESSURE SENSITIVE FOR MANUAL APPLICATION, OR TACK FREE HEAT ACTIVATED FOR MECHANICAL VACUUM-HEAT APPLICATION.
10. THE REFLECTIVE BRIGHTNESS VALUES OF THE REFLECTIVE SHEETING AS COMPARED TO MAGNESIUM OXIDE (MGO) SHALL BE AS GIVEN IN TABLE 605-1 OF THE STANDARD SPECIFICATIONS MANUAL OR NOT LESS THAN 90% OF THE GIVEN VALUES WHEN TOTALLY WET BY RAIN.

OTHERS

1. BEFORE FINAL ACCEPTANCE, THE RIGHT-OF-WAY, BORROW PITS AND ALL GROUND OCCUPIED BY THE CONTRACTOR SHALL BE CLEANED OF ALL RUBBISH, EXCESS MATERIALS, TEMPORARY STRUCTURES AND EQUIPMENT AND ALL PARTS OF THE WORK SHALL BE LEFT IN A NEAT AND PRESENTABLE CONDITION.
2. ANY DEFECTIVE WORK WHETHER THE RESULT OF POOR WORKMANSHIP, USE OF DEFECTIVE MATERIALS, DAMAGE THROUGH CARELESSNESS, OR OF ANY OTHER CAUSE, FOUND PRIOR TO ACCEPTANCE, SHALL BE REMOVED IMMEDIATELY AND REPLACED BY WORK AND MATERIALS WHICH SHALL CONFORM TO THE SPECIFICATIONS.
3. DAMAGES TO ANY PORTION OF WORK BEFORE FINAL ACCEPTANCE EXCEPT DAMAGES DUE TO UNFORESEEABLE CAUSES BEYOND THE CONTROL OF AND WITHOUT FAULT OF NEGLIGENCE BY THE CONTRACTOR SHALL BE REBUILT, REPAIRED AND RESTORED.

REFERENCES



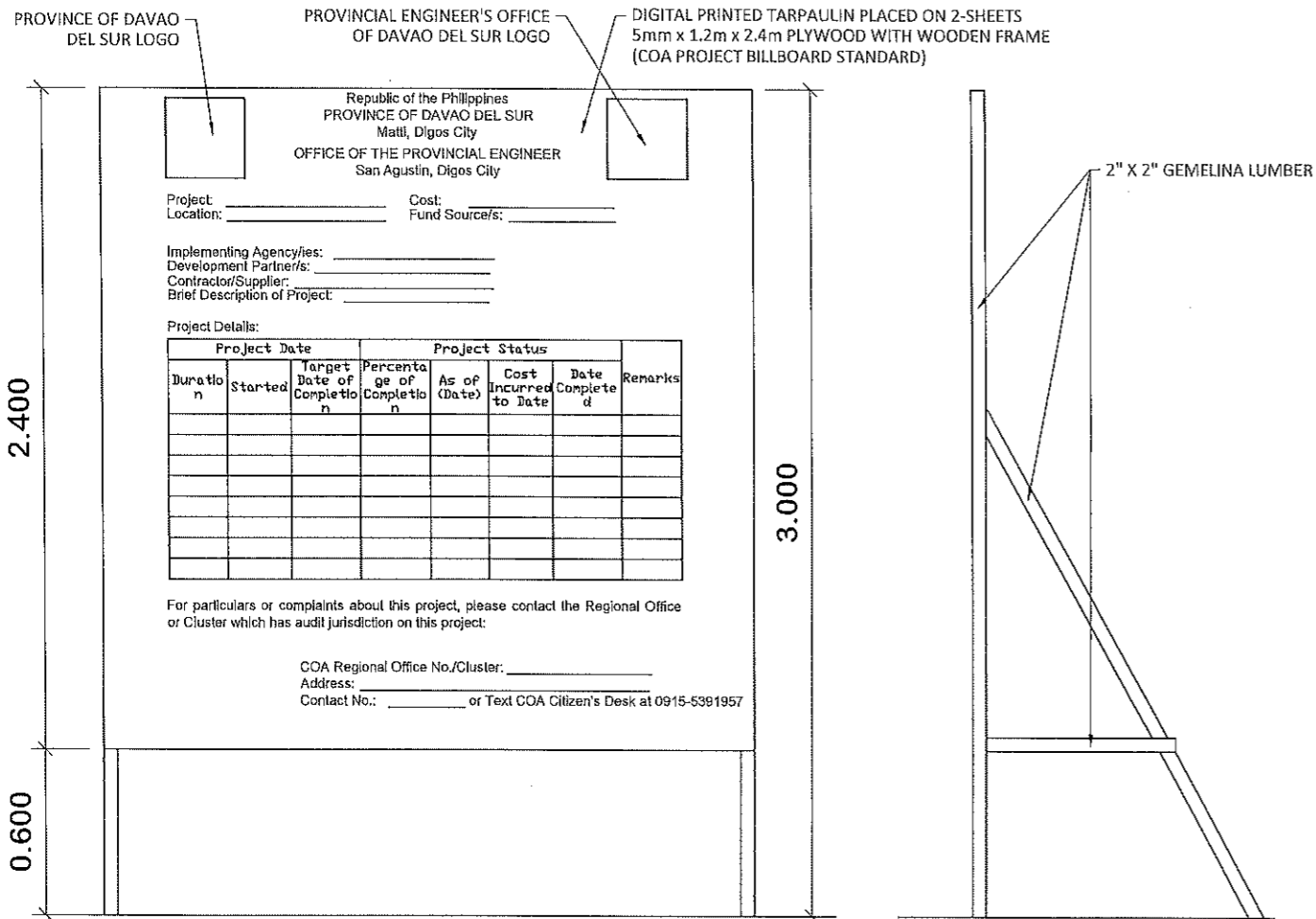

1. REVISED DPWH MANUAL ON HIGHWAY SAFETY DESIGN STANDARDS, MAY 2013 EDITION
  - FOR ROAD SAFETY PLANNING AND DESIGN ACTIVITIES AS WELL AS ROAD SAFETY MAINTENANCE ACTIVITIES SUCH AS THE PROPER WAY OF INSTALLING/APPLYING ROAD SIGNS, ROAD SAFETY DEVICES AND PAVEMENT MARKINGS
  - DO 41, s.2012
2. LABOR CODE OF THE PHILIPPINES AND ITS IMPLEMENTING RULES AND REGULATIONS DOLE DO NO. 13, s.1998, OCCUPATIONAL SAFETY AND HEALTH STANDARDS AND ITS PROCEDURAL GUIDELINES
  - FOR MONITORING, ENFORCEMENT AND IMPLEMENTATION OF CONSTRUCTION SAFETY AND HEALTH
  - DO 56, s.2005
3. DPWH DESIGN CRITERIA, GUIDELINES AND STANDARDS, 2015.
4. GUIDELINES FOR THE PREPARATION OF COST ESTIMATES FOR TRAFFIC MANAGEMENT AND SAFETY & HEALTH REQUIREMENTS FOR THE CONSTRUCTION AND MAINTENANCE OF ROADS, BRIDGES AND SAFETY & HEALTH REQUIREMENTS FOR SCHOOL BUILDINGS, DO 13, s.2018.

 <p>REPUBLIC OF THE PHILIPPINES <b>PROVINCIAL ENGINEER'S OFFICE</b> SAN AGUSTIN, DIGOS CITY, DAVAO DEL SUR</p>	PROJECT TITLE: <b>IMPROVEMENT OF FARM TO MARKET ROAD (FMR)</b>	SURVEYED BY: <b>DONALD A. RELLO</b> ENGINEER I	REVIEWED BY: <b>JOSEPH R. GONZALES</b> ENGINEER III Planning and Programming Division Head	RECOMMENDING APPROVAL: <b>ANGELIE R. GELLA</b> PGADH - Assistant Provincial Engineer OIC - Provincial Engineer (As per Memo, Order No. 22-2023)	APPROVED BY: <b>YVONNE ROMA CAGAS</b> Provincial Governor	<div style="border: 2px solid black; border-radius: 50%; width: 40px; height: 40px; display: flex; align-items: center; justify-content: center; margin: 0 auto;"> <div style="text-align: center;"> <p><b>3</b></p> <hr/> <p><b>11</b></p> </div> </div>
	LOCATION: <b>LAPERAS, SULOP, DAVAO DEL SUR</b>	DESIGNED & PREPARED BY: <b>JOSEPH RYAN B. REDOLOSO</b> ENGINEER II				

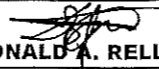
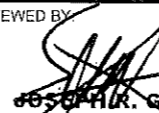

SUMMARY OF QUANTITIES			
ITEM NO.	DESCRIPTION	QTY	UNIT
<b>PART B. OTHER GENERAL REQUIREMENTS</b>			
B.5	Project Billboard/Signboard	2.00	each
B.7(1)	Occupational Safety and Health Program	1.03	months
B.9	Mobilization/Demobilization	1.00	L.S.
<b>PART C. EARTHWORK</b>			
100 (2)	Clearing & Grubbing	1.00	L.S.
102(2)	Surplus Common Excavation	491.77	cu.m.
104(2)a	Embankment from Borrow	107.00	cu.m.
105(1)a	Subgrade Preparation (Common Material)	653.04	sq.m.
<b>PART D. SUBBASE AND BASE COURSE</b>			
200(1)	Aggregate Subbase Course	324.68	cu.m
<b>PART E. SURFACE COURSES</b>			
311(1)b1	Portland Cement Concrete Pavement (Unreinforced), 200mm thk.	702.00	sq.m.

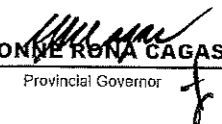
**PROJECT BILLBOARD (COA STANDARD)**  
SCALE  
DNTS

 <p>REPUBLIC OF THE PHILIPPINES <b>PROVINCIAL ENGINEER'S OFFICE</b> SAN AGUSTIN, DIGOS CITY, DAVAO DEL SUR</p>	PROJECT TITLE: <b>IMPROVEMENT OF FARM TO MARKET ROAD (FMR)</b>	SURVEYED BY:  <b>DONALD A. RELLON</b> ENGINEER I	REVIEWED BY:  <b>JOSEPH R. GONZALES</b> ENGINEER II Planning and Programming Division Head	RECOMMENDING APPROVAL:  <b>ANGELIE R. GELLA</b> PGADH - Assistant Provincial Engineer OIC - Provincial Engineer (As per Memo, Order No. 22-2023)	APPROVED BY:  <b>YVONNE RONA CAGAS</b> Provincial Governor	<div style="border: 1px solid black; border-radius: 50%; width: 40px; height: 40px; display: flex; align-items: center; justify-content: center; margin: 0 auto;"> <div style="border-bottom: 1px solid black; width: 100%; text-align: center;">4</div> <div style="width: 100%; text-align: center;">11</div> </div>
	LOCATION: <b>LAPERAS, SULOP, DAVAO DEL SUR</b>	DESIGNED & PREPARED BY:  <b>JOSEPH RYAN B. REDOLOSO</b> ENGINEER II				

BM-1:  
 LOC 51N 0755173  
 UTM 0724479  
 ELEVATION: 441m

BM-2:  
 LOC 51N 0755345  
 UTM 0724538  
 ELEVATION: 412m

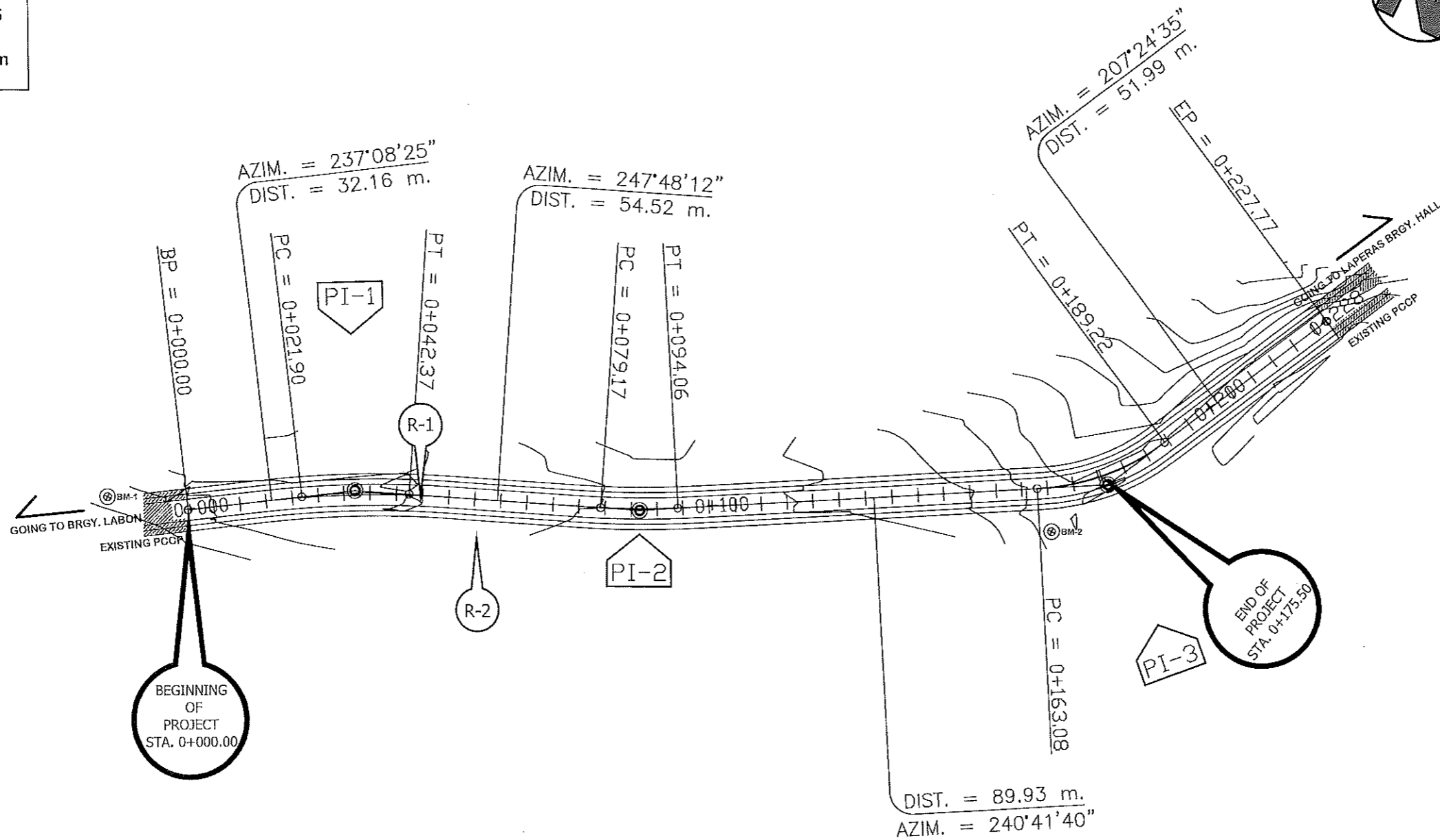

BEGINNING OF PROJECT STA. 0+000.00

END OF PROJECT STA. 0+175.50

**GENERAL PLAN**  
 SCALE DNTS

(R-1) - STARWOOD - 5.39m FROM P.I. (1)  
 (R-2) - CHAPEL - 12.57m FROM P.I. (1)

<p>REPUBLIC OF THE PHILIPPINES  <b>PROVINCIAL ENGINEER'S OFFICE</b>          SAN AGUSTIN, DIGOS CITY, DAVAO DEL SUR</p>	PROJECT TITLE: <b>IMPROVEMENT OF FARM TO MARKET ROAD (FMR)</b>	SURVEYED BY: <b>DONALD A. RELLO</b> ENGINEER I	REVIEWED BY:  <b>JOSEPH R. GONZALES</b> ENGINEER II Planning and Programming Division Head	RECOMMENDING APPROVAL:  <b>ANGELIE R. GELLA</b> PGADH - Assistant Provincial Engineer OIC - Provincial Engineer (As per Memo, Order No. 22-2023)	APPROVED BY:  <b>YVONNE RONA CAGAS</b> Provincial Governor	<div style="border: 1px solid black; border-radius: 50%; width: 40px; height: 40px; display: flex; flex-direction: column; align-items: center; justify-content: center;"> <span style="font-size: 24px; font-weight: bold;">5</span> <hr style="width: 100%;"/> <span style="font-size: 24px; font-weight: bold;">11</span> </div>
	LOCATION: <b>LAPERAS, SULOP, DAVAO DEL SUR</b>	DESIGNED & PREPARED BY:  <b>JOSEPH RYAN B. REDOLOSO</b> ENGINEER II				

ELEMENTS OF CURVE												
PI NO.	PI STATION	NORTHING	EASTING	I	R	T	E	Lo	PC	PT	V (kph)	a (%)
PI-1	0+032.16	755,213.467	724,474.982	10°39'47"	110.00	10.27	0.48	20.47	0+021.90	0+042.37		
PI-2	0+086.62	755,234.055	724,525.463	7°06'32"	120.00	7.45	0.23	14.89	0+079.17	0+094.05		
PI-3	0+176.53	755,278.082	724,603.083	33°17'06"	45.00	13.45	1.97	26.14	0+163.08	0+189.22		

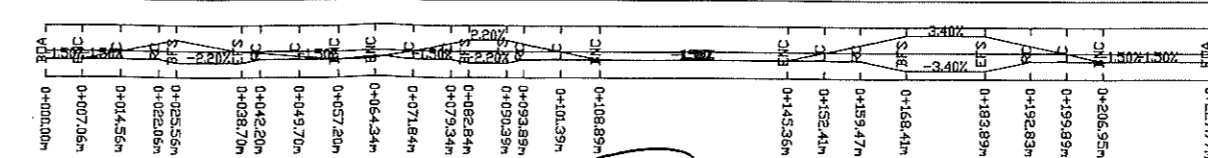
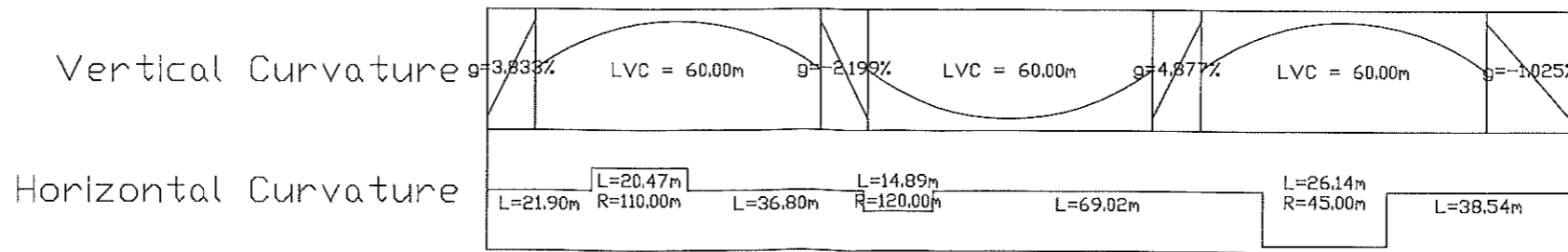
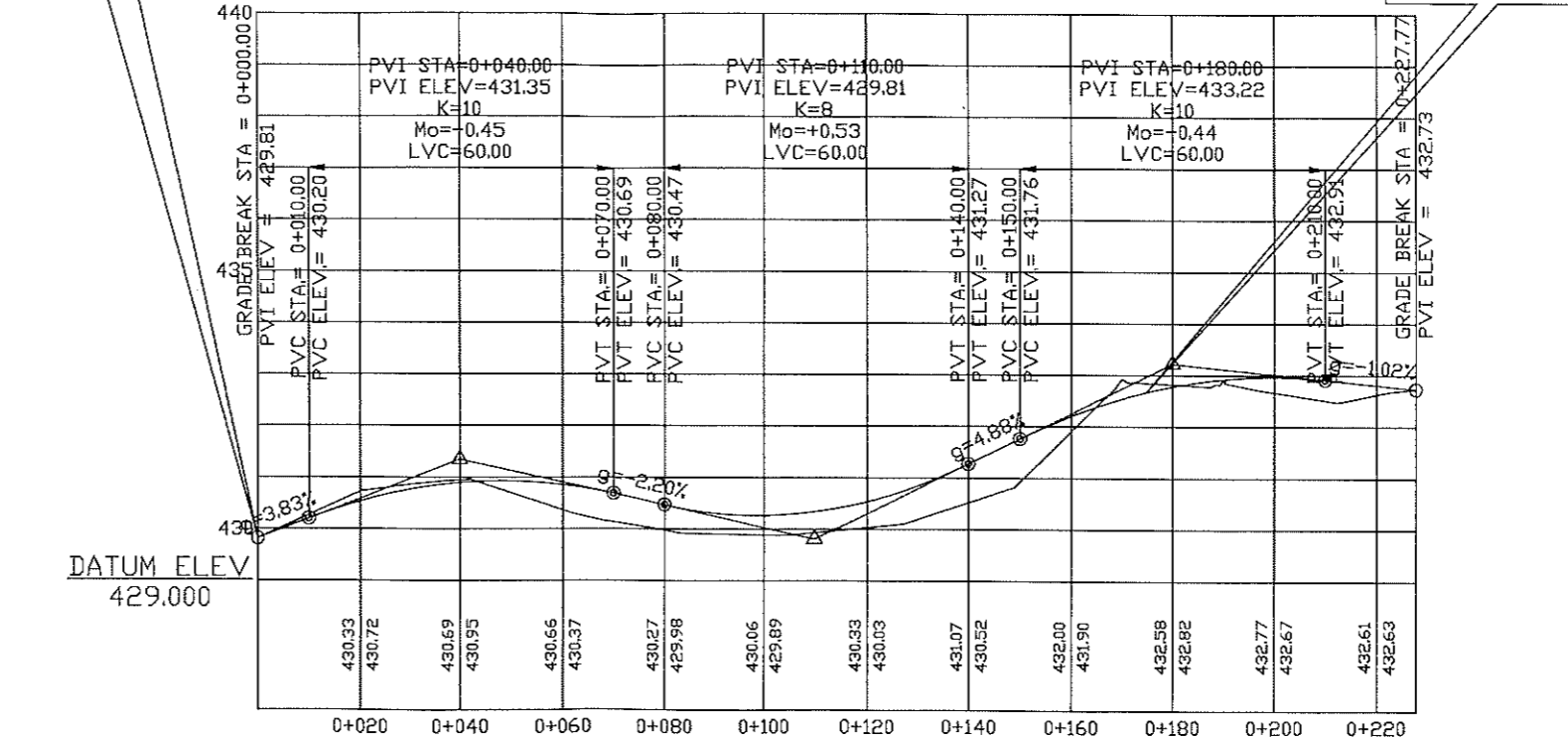
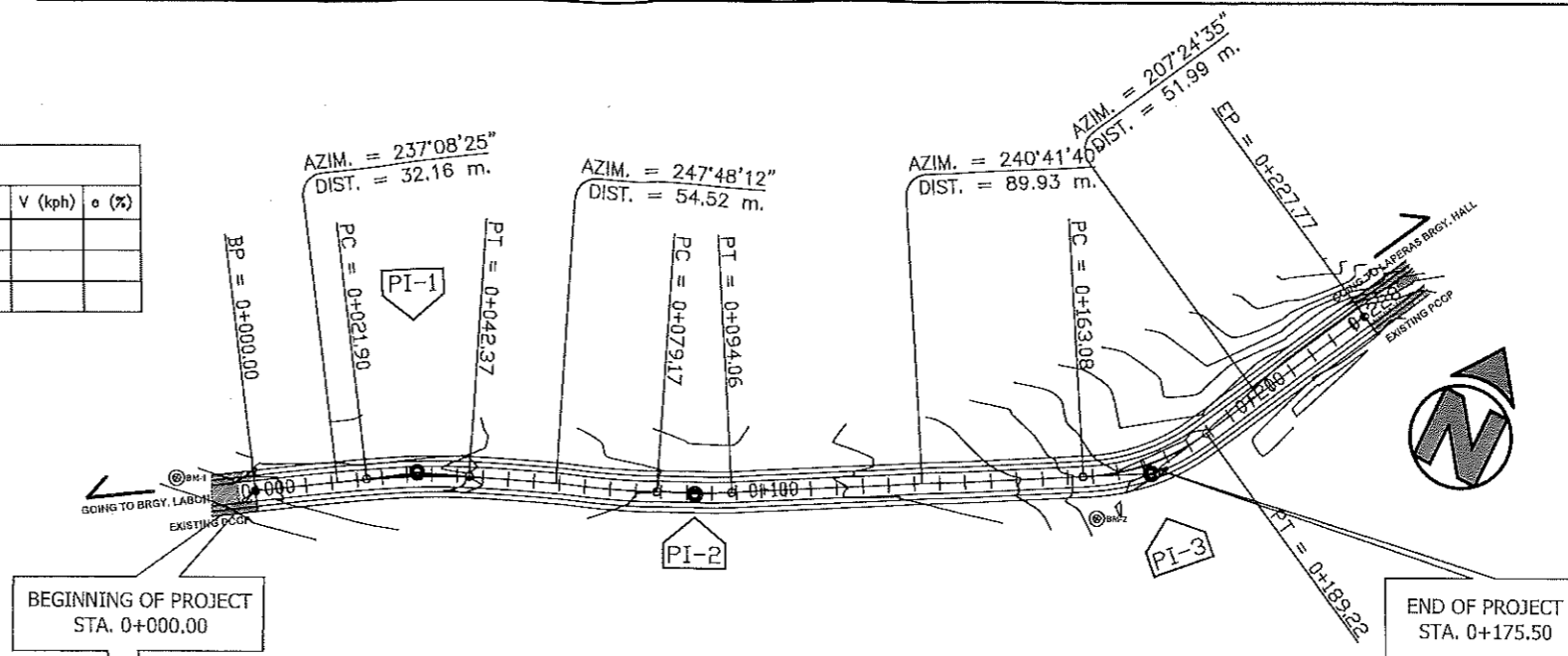

 <p>REPUBLIC OF THE PHILIPPINES PROVINCIAL ENGINEER'S OFFICE SAN AGUSTIN, DIGOS CITY, DAVAO DEL SUR</p>	PROJECT TITLE: <b>IMPROVEMENT OF FARM TO MARKET ROAD (FMR)</b>	SURVEYED BY: <b>DONALD A. RELLO</b> ENGINEER I	REVIEWED BY: <b>JOSEPH R. GONZALES</b> ENGINEER III Planning and Programming Division Head	RECOMMENDING APPROVAL: <b>ANGELIE R. GELLA</b> PGADH - Assistant Provincial Engineer OIC - Provincial Engineer (As per Memo, Order No. 22-2023)	APPROVED BY: <b>YVONNE RONALD CAGAS</b> Provincial Governor	<div style="border: 1px solid black; border-radius: 50%; width: 40px; height: 40px; display: flex; flex-direction: column; align-items: center; justify-content: center; margin: 0 auto;"> <span style="font-size: 24px; font-weight: bold;">10</span> <span style="font-size: 24px; font-weight: bold;">11</span> </div>
	LOCATION: <b>LAPERAS, SULOP, DAVAO DEL SUR</b>	DESIGNED & PREPARED BY: <b>JOSEPH RYAN B. REDOLOSO</b> ENGINEER II				



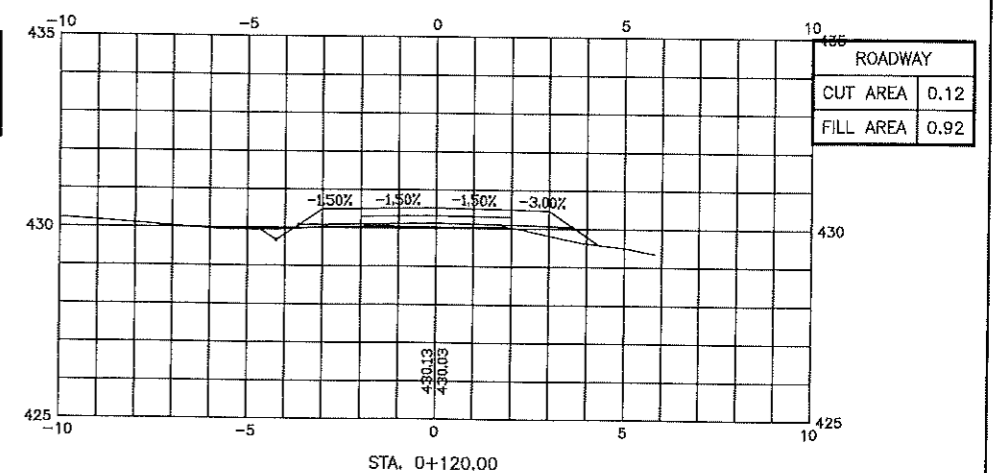
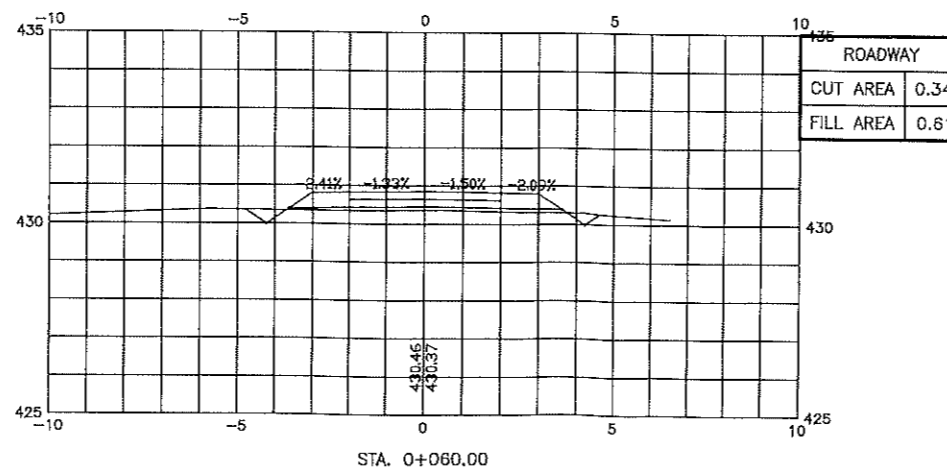
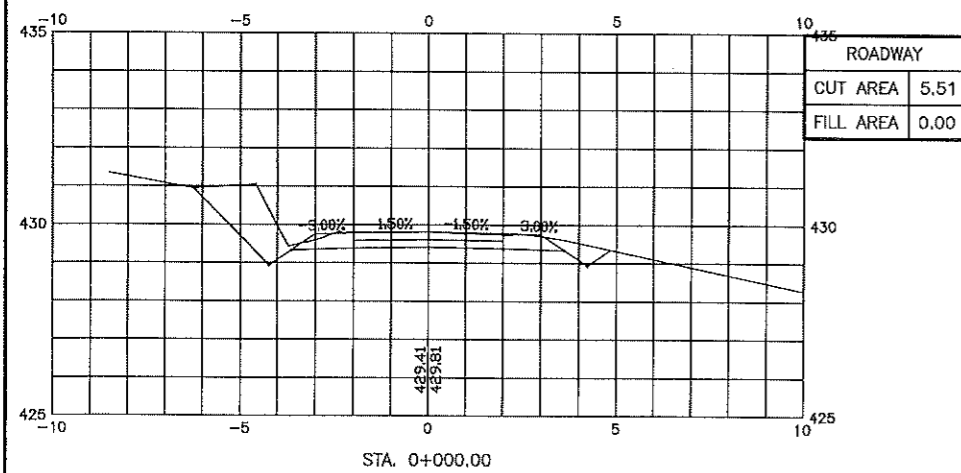
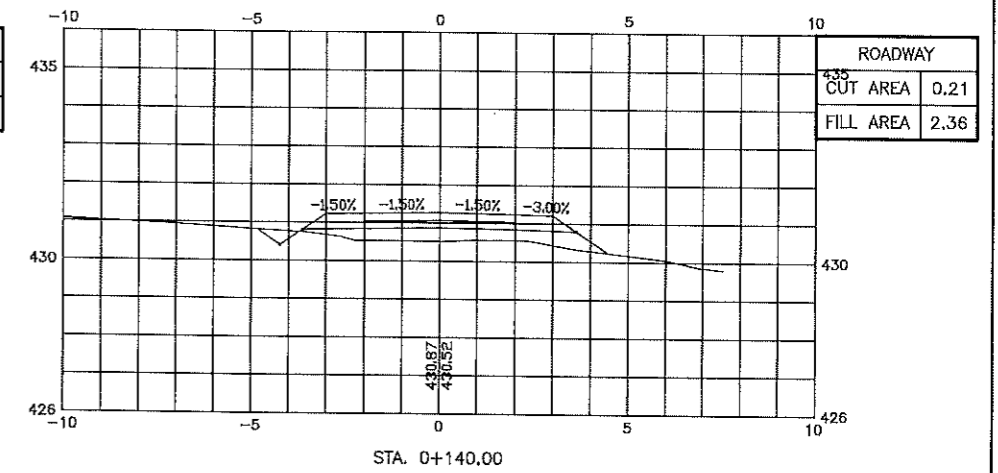
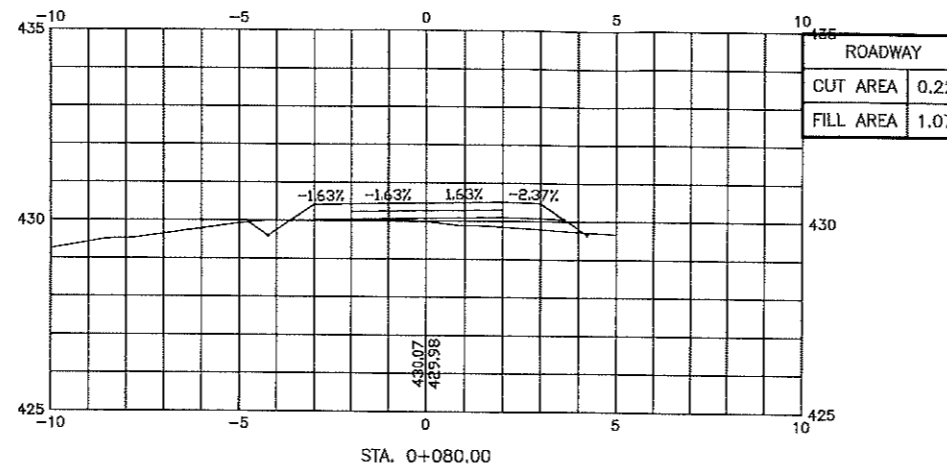
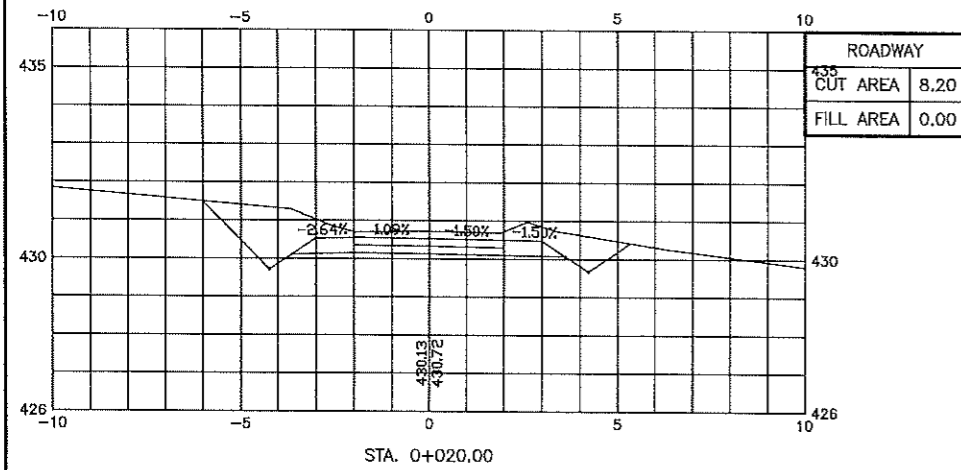
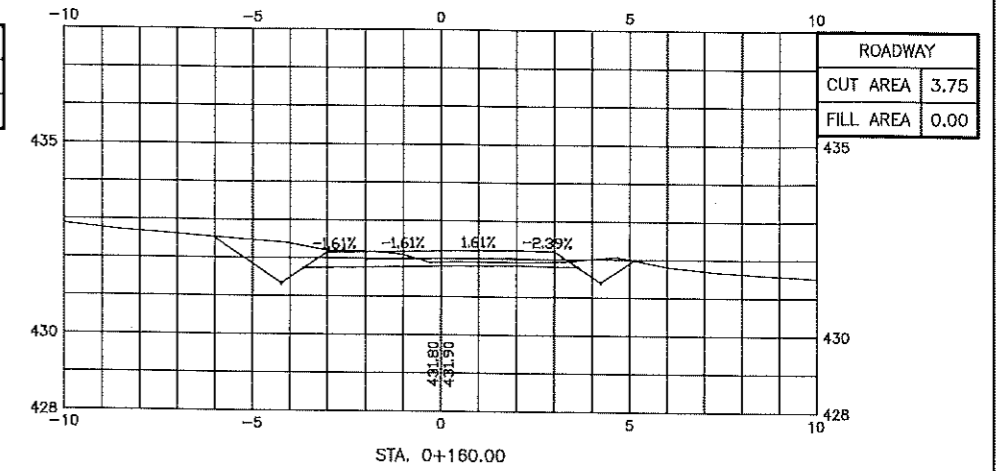
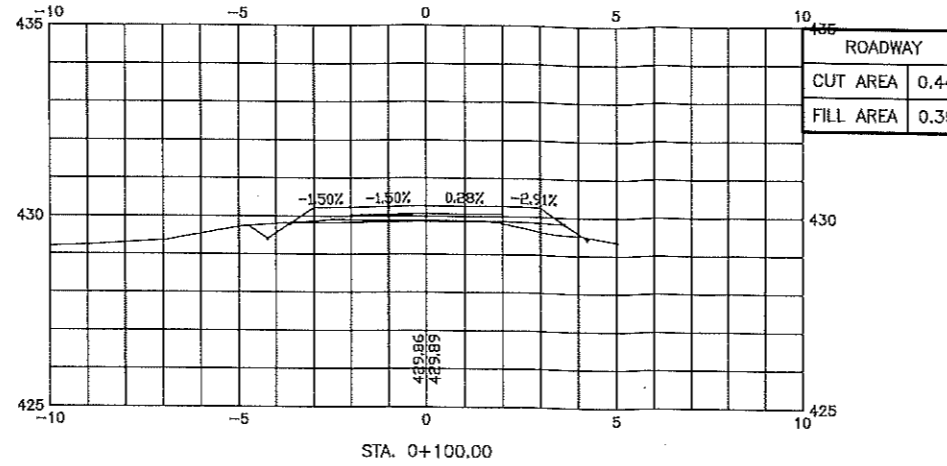
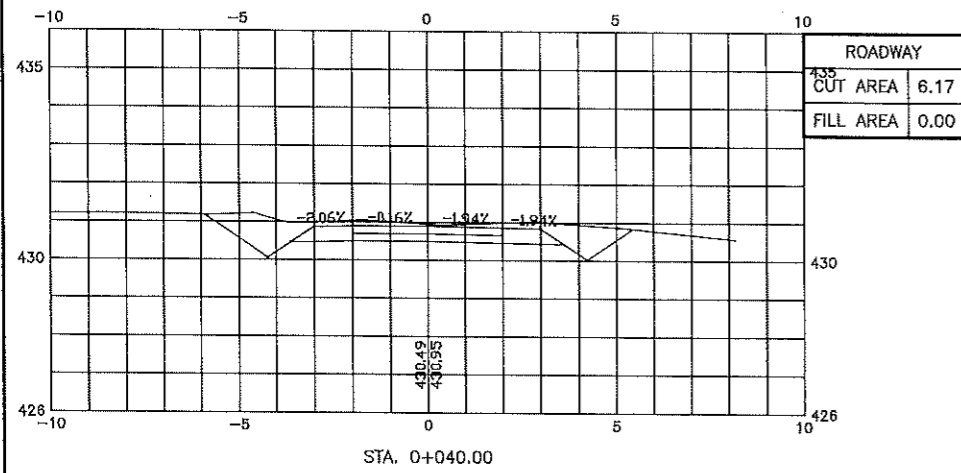

REPUBLIC OF THE PHILIPPINES  
**PROVINCIAL ENGINEER'S OFFICE**  
 SAN AGUSTIN, DIGOS CITY, DAVAO DEL SUR

PROJECT TITLE:  
**IMPROVEMENT OF FARM TO MARKET ROAD (FMR)**

LOCATION:  
**LAPERAS, SULOP, DAVAO DEL SUR**

SURVEYED BY:  
**DONALD A. RELLON**  
 ENGINEER I

DESIGNED & PREPARED BY:  
**JOSEPH RYAN B. REDOLOSO**  
 ENGINEER II

REVIEWED BY:  
**JOSEPH R. GONZALES**  
 ENGINEER III  
 Planning and Programming Division Head

RECOMMENDING APPROVAL:  
**ANGELIE R. GELLA**  
 PGADH - Assistant Provincial Engineer  
 OIC - Provincial Engineer  
 (As per Memo. Order No. 22-2023)

APPROVED BY:  
**YVONNE RON CAGAS**  
 Provincial Governor

11  
 11