

P M O

Republic of the Philippines
PROVINCE OF DAVAO DEL SUR
Office of the Governor

**PROCUREMENT MANAGEMENT OFFICE
BIDS AND AWARDS COMMITTEE**

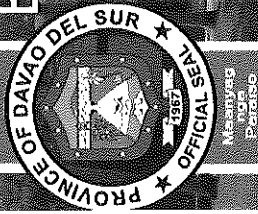

Mobile Nos. 0905-229-0526/0908-332-2024 (Goods), 0948-768-5848 (Infra)

Telefax: (082) 553-9579

Website: www.davaodelsur.gov.ph/pgo-bac

Email Add.: bac.davaodelsur2@gmail.com/sbacdavaodelsur@gmail.com

I Love Davao del Sur

BIDDING DOCUMENTS

One Job Order for the REPAIR/ IMPROVEMENT OF FLOOD CONTROL STRUCTURE located at SINAWILAN, DIGOS CITY, DAVAO DEL SUR

all in accordance to plans, specifications and scope of work and the Green Procurement Policy as adopted by Executive Order No. 30 series of 2019

IB No. C-136-23

**Date of Opening of Bids: October 03, 2023 at 09:00 A.M.
Start Date for Issuance of Bidding Documents: September 12, 2023**

**Sixth Edition
July 2020**

TABLE OF CONTENTS

SECTION I.	INVITATION TO BID
SECTION II.	INSTRUCTIONS TO BIDDERS
SECTION III.	BID DATA SHEET
SECTION IV.	GENERAL CONDITIONS OF CONTRACT
SECTION V.	SPECIAL CONDITIONS OF CONTRACT
SECTION VI.	SPECIFICATIONS
SECTION VII.	DRAWINGS
SECTION VIII.	BILL OF QUANTITIES
SECTION IX.	CHECKLIST OF TECHNICAL AND FINANCIAL DOCUMENTS
SECTION X.	OTHER DOCUMENTS

fi

SECTION I.

INVITATION TO BID

H

Invitation to Bid for C-136-23

REPAIR/ IMPROVEMENT OF FLOOD CONTROL STRUCTURE located at SINAWILAN, DIGOS CITY, DAVAO DEL SUR



all in accordance to plans, specifications and scope of work and the Green Procurement Policy as adopted by Executive Order No. 30 series of 2019

1. The Provincial Government of Davao del Sur, through the CY 2023 – GENERAL FUND intends to apply the sum of P6,000,000.00 being the Approved Budget for the Contract (ABC) to payments under the contract for IB No. C-136-23. Bids received in excess of the ABC shall be automatically rejected at bid opening.
2. The Provincial Government of Davao del Sur now invites bids for the above Procurement Project. Completion of the Works is required 100 Calendar Days Contract Duration. Bidders should have completed a contract similar to the Project. The description of an eligible bidder is contained in the Bidding Documents, particularly, in Section II (Instructions to Bidders).
3. Bidding will be conducted through open competitive bidding procedures using non-discretionary “*pass/fail*” criterion as specified in the 2016 revised Implementing Rules and Regulations (IRR) of Republic Act (RA) No. 9184.
4. Interested bidders may obtain further information from Provincial Government of Davao del Sur and inspect the Bidding Documents at the address given below during 8:00 A.M. – 4:00 P.M., Monday to Friday:

Engr. SHEILA MAE A. ZAPANTA, MPA
Administrative Officer IV
Head, BAC Secretariat for Infrastructure Projects
5. A complete set of Bidding Documents may be acquired by interested bidders on September 12 – October 03, 2023, at the Office of the BAC Secretariat Room 16, Executive Building, Capitol Compound, Brgy. Matti, Digos City upon accomplishing a bidder’s assessment slip pursuant to the latest Guidelines issued by GPPB, in the amount of P10,000.00. The Provincial Government of Davao del Sur shall allow the bidder to present its proof of payment for the fees upon payment of a non-refundable fee for the Bidding Documents in the amount stated above, to the Provincial Treasurer’s Office. An authorization from the proprietor of the company shall be presented in case the latter opted to send representative/s in his/her behalf. Only bidders who purchased the Bidding Documents with corresponding official receipt of the bidding documents will be allowed to submit bids. Eligibility/Technical and Financial documents must be book bound and properly tabbed at right side. The bidder will prepare (3) sets of book bound bidding documents with corresponding proper markings (Original Copy, Copy 1 and Copy 2), respectively. Any documents submitted, not book bound shall be rejected outright. For the Financial Proposals not exceeding ten (10) pages may be book bound or securely stapled.
6. The Provincial Government of Davao del Sur will hold a Pre-Bid Conference on September 19, 2023, 9:00 A.M., at Ralota Hall, Gov. Douglas Ra. Cagas Cultural, Sports and Business Complex, Barangay Matti, Digos City, Davao del Sur, which shall be open to prospective bidders.

7. Bids must be duly received by the BAC Secretariat at the following through manual submission. Late bids shall not be accepted.
- Advance dropping (before **October 3, 2023**) – Room 16, Procurement Management Office (Infrastructure Projects), Capitol Building, Mati, Digos City.
 - Date of opening (**October 3, 2023, before 9:00 A.M.**) – Ralota Hall, Davao del Sur Coliseum, Mati, Digos City.
8. All bids must be accompanied by a bid security in any of the acceptable forms and in the amount stated in ITB Clause 16.
9. Bid opening shall be on **October 3, 2023 at 9:00 A.M., Ralota Hall, Gov. Douglas Ra. Cagas Cultural, Sports and Business Complex, Barangay Mati, Digos City, Davao del Sur**. Bids will be opened in the presence of the bidders' representatives who choose to attend the activity.
10. The **Provincial Government of Davao del Sur** reserves the right to reject any and all bids, declare a failure of bidding, or not award the contract at any time prior to contract award in accordance with Sections 35.6 and 41 of the 2016 revised Implementing Rules and Regulations (IRR) of RA No. 9184, without thereby incurring any liability to the affected bidder or bidders.
11. For further information, please refer to:
- The BAC CHAIRPERSON**
Provincial Government of Davao del Sur
Contact No: 09487685848
Email Address: sbacdavaodelsur@gmail.com
- Engr. SHEILA MAE A. ZAPANTA, MPA**
Head, BAC Secretariat for Infrastructure Projects
PGO – Procurement Management Office
Office of BAC Secretariat for Infrastructure Projects
Room 16, Provincial Capitol Building, Mati, Digos City, Davao del Sur
Contact No: 09487685848; Email Address: sbacdavaodelsur@gmail.com
12. You may visit the website, www.davaodelsur.gov.ph, for downloading of Bidding Documents.

September 11, 2023

DESSAMIE BUXTI SANCHEZ, CPA, JD
Provincial Budget Officer
BAC Chairperson 

SECTION II.

INSTRUCTION TO BIDDERS

H

Section II. Instructions to Bidders

1. Scope of Bid

The **REPAIR/ IMPROVEMENT OF FLOOD CONTROL STRUCTURE located at SINAWILAN, DIGOS CITY, DAVAO DEL SUR**, with Project Identification Number C-136-23.

The Procurement Project (referred to herein as "**REPAIR/ IMPROVEMENT OF FLOOD CONTROL STRUCTURE located at SINAWILAN, DIGOS CITY, DAVAO DEL SUR**") is for the construction of Works, as described in Section VI (Specifications).

2. Funding Information

- 2.1. The GOP through the source of funding as indicated below for **CY 2023** in the amount of **P6,000,000.00**.
- 2.2. The source of funding is **GENERAL FUND**:

3. Bidding Requirements

The Bidding for the Project shall be governed by all the provisions of RA No. 9184 and its 2016 revised IRR, including its Generic Procurement Manual and associated policies, rules and regulations as the primary source thereof, while the herein clauses shall serve as the secondary source thereof.

Any amendments made to the IRR and other GPPB issuances shall be applicable only to the ongoing posting, advertisement, or invitation to bid by the BAC through the issuance of a supplemental or bid bulletin.

The Bidder, by the act of submitting its Bid, shall be deemed to have inspected the site, determined the general characteristics of the contracted Works and the conditions for this Project, such as the location and the nature of the work; (b) climatic conditions; (c) transportation facilities; (c) nature and condition of the terrain, geological conditions at the site communication facilities, requirements, location and availability of construction aggregates and other materials, labor, water, electric power and access roads; and (d) other factors that may affect the cost, duration and execution or implementation of the contract, project, or work and examine all instructions, forms, terms, and project requirements in the Bidding Documents.

4. Corrupt, Fraudulent, Collusive, Coercive, and Obstructive Practices

The Procuring Entity, as well as the Bidders and Contractors, shall observe the highest standard of ethics during the procurement and execution of the contract. They or through an agent shall not engage in corrupt, fraudulent, collusive, coercive, and obstructive practices defined under Annex "F" of the 2016 revised IRR of RA No. 9184 or other integrity violations in competing for the Project.

5. Eligible Bidders

- 5.1. Only Bids of Bidders found to be legally, technically, and financially capable will be evaluated.
- 5.2. The Bidder must have an experience of having completed a Single Largest Completed Contract (SLCC) that is similar to this Project, equivalent to at least fifty percent (50%) of the ABC adjusted, if necessary, by the Bidder to current prices using the PSA's CPI,

except under conditions provided for in Section 23.4.2.4 of the 2016 revised IRR of RA No. 9184.

A contract is considered to be “similar” to the contract to be bid if it has the major categories of work stated in the **BDS**.

5.3. For Foreign-funded Procurement, the Procuring Entity and the foreign government/foreign or international financing institution may agree on another track record requirement, as specified in the Bidding Document prepared for this purpose.

5.4. The Bidders shall comply with the eligibility criteria under Section 23.4.2 of the 2016 IRR of RA No. 9184.

6. Origin of Associated Goods

There is no restriction on the origin of Goods other than those prohibited by a decision of the UN Security Council taken under Chapter VII of the Charter of the UN.

7. Subcontracts

7.1. **Subcontracting is not allowed.**

8. Pre-Bid Conference

The Procuring Entity will hold a pre-bid conference for this Project on the **September 19, 2023, at 9:00 A.M., Ralota Hall, Gov. Douglas Ra. Cagas Cultural Sports and Business Complex, Barangay Matti, Digos City, Davao del Sur** as indicated in paragraph 6 of the IB.

9. Clarification and Amendment of Bidding Documents

Prospective bidders may request for clarification on and/or interpretation of any part of the Bidding Documents. Such requests must be in writing and received by the Procuring Entity, either at its given address or through electronic mail indicated in the IB, at least ten (10) calendar days before the deadline set for the submission and receipt of Bids.

10. Documents Comprising the Bid: Eligibility and Technical Components

10.1. The first envelope shall contain the eligibility and technical documents of the Bid as specified in **Section IX. Checklist of Technical and Financial Documents**.

10.2. If the eligibility requirements or statements, the bids, and all other documents for submission to the BAC are in foreign language other than English, it must be accompanied by a translation in English, which shall be authenticated by the appropriate Philippine foreign service establishment, post, or the equivalent office having jurisdiction over the foreign bidder's affairs in the Philippines. For Contracting Parties to the Apostille Convention, only the translated documents shall be authenticated through an apostille pursuant to GPPB Resolution No. 13-2019 dated 23 May 2019. The English translation shall govern, for purposes of interpretation of the bid.

10.3. A valid special PCAB License in case of Joint Ventures, and registration for the type and cost of the contract for this Project. Any additional type of Contractor license or permit shall be indicated in the **BDS**.

10.4. A List of Contractor's key personnel (e.g., Project Manager, Project Engineers, Materials Engineers, and Foremen) assigned to the contract to be bid, with their complete qualification and experience data shall be provided. These key personnel must meet the required minimum years of experience set in the **BDS**.

10.5. A List of Contractor's major equipment units, which are owned, leased, and/or under purchase agreements, supported by proof of ownership, certification of availability of equipment from the equipment lessor/vendor for the duration of the project, as the case may be, must meet the minimum requirements for the contract set in the **BDS**.

11. Documents Comprising the Bid: Financial Component

- 11.1. The second bid envelope shall contain the financial documents for the Bid as specified in **Section IX. Checklist of Technical and Financial Documents**.
- 11.2. Any bid exceeding the ABC indicated in paragraph 1 of the **IB** shall not be accepted.
- 11.3. For Foreign-funded procurement, a ceiling may be applied to bid prices provided the conditions are met under Section 31.2 of the 2016 revised IRR of RA No. 9184.

12. Alternative Bids

Bidders shall submit offers that comply with the requirements of the Bidding Documents, including the basic technical design as indicated in the drawings and specifications. Unless there is a value engineering clause in the **BDS**, alternative Bids shall not be accepted.

13. Bid Prices

All bid prices for the given scope of work in the Project as awarded shall be considered as fixed prices, and therefore not subject to price escalation during contract implementation, except under extraordinary circumstances as determined by the NEDA and approved by the GPPB pursuant to the revised Guidelines for Contract Price Escalation guidelines.

14. Bid and Payment Currencies

- 14.1. Bid prices may be quoted in the local currency or tradeable currency accepted by the BSP at the discretion of the Bidder. However, for purposes of bid evaluation, Bids denominated in foreign currencies shall be converted to Philippine currency based on the exchange rate as published in the BSP reference rate bulletin on the day of the bid opening.
- 14.2. Payment of the contract price shall be made in: **Philippine Pesos**.

15. Bid Security

- 15.1. The Bidder shall submit a Bid Securing Declaration or any form of Bid Security in the amount indicated in the **BDS**, which shall be not less than the percentage of the ABC in accordance with the schedule in the **BDS**.
- 15.2. The Bid and bid security shall be valid for **120 Calendar Days** upon opening of bids. Any bid not accompanied by an acceptable bid security shall be rejected by the Procuring Entity as non-responsive.

16. Sealing and Marking of Bids

Each Bidder shall submit one copy of the first and second components of its Bid.

The Procuring Entity may request additional hard copies and/or electronic copies of the Bid. However, failure of the Bidders to comply with the said request shall not be a ground for disqualification.

If the Procuring Entity allows the submission of bids through online submission to the given website or any other electronic means, the Bidder shall submit an electronic copy of its Bid,

which must be digitally signed. An electronic copy that cannot be opened or is corrupted shall be considered non-responsive and, thus, automatically disqualified.

17. Deadline for Submission of Bids

17.1 Bids must be delivered to the Ralota Hall, Gov. Douglas Ra. Cagas Cultural Sports and Business Complex, Barangay Matti, Digos City, Davao del Sur **on or before October 03, 2023 at 9:00 A.M.** Late bids shall not be accepted. All bids must be accompanied by a bid security in any of the acceptable forms and in the amount stated in ITB Clause 18.

18. Opening and Preliminary Examination of Bids

18.1. The BAC shall open the Bids in public at the time, on the date, and at the place specified in paragraph 9 of the IB. The Bidders' representatives who are present shall sign a register evidencing their attendance. In case videoconferencing, webcasting or other similar technologies will be used, attendance of participants shall likewise be recorded by the BAC Secretariat.

In case the Bids cannot be opened as scheduled due to justifiable reasons, the rescheduling requirements under Section 29 of the 2016 revised IRR of RA No. 9184 shall prevail.

18.2. The preliminary examination of Bids shall be governed by Section 30 of the 2016 revised IRR of RA No. 9184.

19. Detailed Evaluation and Comparison of Bids

19.1. The Procuring Entity's BAC shall immediately conduct a detailed evaluation of all Bids rated "*passed*" using non-discretionary pass/fail criteria. The BAC shall consider the conditions in the evaluation of Bids under Section 32.2 of 2016 revised IRR of RA No. 9184.

19.2. If the Project allows partial bids, all Bids and combinations of Bids as indicated in the BDS shall be received by the same deadline and opened and evaluated simultaneously so as to determine the Bid or combination of Bids offering the lowest calculated cost to the Procuring Entity. Bid Security as required by ITB Clause 15 shall be submitted for each contract (lot) separately.

19.3. In all cases, the NFCC computation pursuant to Section 23.4.2.6 of the 2016 revised IRR of RA No. 9184 must be sufficient for the total of the ABCs for all the lots participated in by the prospective Bidder.

20. Post Qualification

Within a non-extendible period of five (5) calendar days from receipt by the Bidder of the notice from the BAC that it submitted the Lowest Calculated Bid, the Bidder shall submit its latest income and business tax returns filed and paid through the BIR Electronic Filing and Payment System (eFPS), and other appropriate licenses and permits required by law and stated in the BDS.

21. Signing of the Contract

The documents required in Section 37.2 of the 2016 revised IRR of RA No. 9184 shall form part of the Contract. Additional Contract documents are indicated in the BDS.

SECTION III.

BID DATA SHEET

4

Bid Data Sheet

(IB No.: C-136-23)

ITB Clause	For this purpose, contracts similar to the Project refer to contracts which have the same major categories of work, which shall be:
5.2	Flood Control: Construction – Shore Protection (Seawall, Breakwater)
7.1	(based on DPWH DO 14 Series of 2017) Subcontracting is not allowed.
10.3	“No further instructions.”
10.4	The key personnel must meet the required minimum years of experience set below: <u>Key Personnel</u> <u>General Experience</u> <u>Relevant Experience</u>
10.5	“No further instructions.” The minimum major equipment requirements are the following: <u>Equipment</u> <u>Capacity</u> <u>Number of Units</u>
12	None.
15.1	The bid security shall be in the form of a Bid Securing Declaration or any of the following forms and amounts: a. The amount of not less than P120,000.00 [two percent (2%) of ABC], if bid security is in cash, cashier's/manager's check, bank draft/guarantee or irrevocable letter of credit; b. The amount of not less than P300, 000.00 [five percent (5%) of ABC], if bid security is in Surety Bond.
19.2	Partial bid is not allowed. The infrastructure project is packaged in a single lot and the lot shall not be divided into sub-lots for the purpose of bidding, evaluation, and contract award. In all cases, the NFCC computation must be sufficient for the contract to be awarded to the Bidder. <i>Permits and Clearances as required by the End-User.</i>
20	<i>Post-Qualification Requirements: Latest Income Tax Returns, Business Tax Returns for the last 6 months.</i>
21	1. Presentation of the Bidding Documents a. Envelope 1 (Eligibility/ Technical Documents) One (1) ORIGINAL COPY, another copy for COPY 1, and another copy for COPY 2. b. Envelope 2 (Financial Proposal) One (1) ORIGINAL COPY, another copy for COPY 1, and another copy for COPY 2. Such documents shall be duly signed by the bidders or its duly authorized representative/s.

fo

Eligibility/Technical and Financial Proposal must be book bound and properly tabbed at the right side. Any documents submitted not book bound shall be rejected outright. For the Financial Proposal not exceeding ten (10) pages maybe book bound or securely stapled.

All copies must be properly marked (ORIGINAL COPY, COPY 1 AND COPY 2)

Envelope 1 and Envelope 2 must be properly sealed, and will be placed in one sealed mother envelope.

2. Other documents/materials to comply with other non-discretionary criteria and requirements as stated in the Instruction to Bidders:

- **Construction Methods**
- **Construction schedule and S-Curve**
- **Pert-CPM**
- **Manpower Utilization Schedule**
- **Equipment Utilization Schedule**
- **Construction Safety & Health Program**
- **Affidavit of Site Inspection**
- **Duly Notarized Certification as to compliance to Labor Laws and Standard**

The DOLE approved Construction Safety and Health Program is required before entering into Contract.

f

SECTION IV.

**GENERAL CONDITIONS
OF CONTRACT**

4

General Conditions of Contract

1. Scope of Contract

This Contract shall include all such items, although not specifically mentioned, that can be reasonably inferred as being required for its completion as if such items were expressly mentioned herein. All the provisions of RA No. 9184 and its 2016 revised IRR, including the Generic Procurement Manual, and associated issuances, constitute the primary source for the terms and conditions of the Contract, and thus, applicable in contract implementation. Herein clauses shall serve as the secondary source for the terms and conditions of the Contract.

This is without prejudice to Sections 74.1 and 74.2 of the 2016 revised IRR of RA No. 9184 allowing the GPPB to amend the IRR, which shall be applied to all procurement activities, the advertisement, posting, or invitation of which were issued after the effectivity of the said amendment.

2. Sectional Completion of Works

If sectional completion is specified in the Special Conditions of Contract (SCC), references in the Conditions of Contract to the Works, the Completion Date, and the Intended Completion Date shall apply to any Section of the Works (other than references to the Completion Date and Intended Completion Date for the whole of the Works).

3. Possession of Site

3.1 The Procuring Entity shall give possession of all or parts of the Site to the Contractor based on the schedule of delivery indicated in the SCC, which corresponds to the execution of the Works. If the Contractor suffers delay or incurs cost from failure on the part of the Procuring Entity to give possession in accordance with the terms of this clause, the Procuring Entity's Representative shall give the Contractor a Contract Time Extension and certify such sum as fair to cover the cost incurred, which sum shall be paid by Procuring Entity.

3.2 If possession of a portion is not given by the above date, the Procuring Entity will be deemed to have delayed the start of the relevant activities. The resulting adjustments in contract time to address such delay may be addressed through contract extension provided under Annex "E" of the 2016 revised IRR of RA No. 9184.

4. The Contractor's Obligations

The Contractor shall employ the key personnel named in the Schedule of Key Personnel indicating their designation, in accordance with ITB Clause 10.3 and specified in the **BDS**, to carry out the supervision of the Works.

The Procuring Entity will approve any proposed replacement of key personnel only if their relevant qualifications and abilities are equal to or better than those of the personnel listed in the Schedule.

5. Performance Security

5.1. Within ten (10) calendar days from receipt of the Notice of Award from the Procuring Entity but in no case later than the signing of the contract by both parties, the successful

Bidder shall furnish the performance security in any of the forms prescribed in Section 39 of the 2016 revised IRR.

- 5.2. The Contractor, by entering into the Contract with the Procuring Entity, acknowledges the right of the Procuring Entity to institute action pursuant to RA No. 3688 against any subcontractor be they an individual, firm, partnership, corporation, or association supplying the Contractor with labor, materials and/or equipment for the performance of this Contract.

6. Site Investigations

The Contractor, in preparing the Bid, shall rely on any Site Investigation Reports referred to in the SCC supplemented by any information obtained by the Contractor.

7. Warranty

- 7.1. In case the Contractor fails to undertake the repair works under Section 62.2.2 of the 2016 revised IRR, the Procuring Entity shall forfeit its performance security, subject its property(ies) to attachment or garnishment proceedings, and perpetually disqualify it from participating in any public bidding. All payables of the GOP in his favor shall be offset to recover the costs.

- 7.2. The warranty against Structural Defects/Failures, except that occasioned-on force majeure, shall cover the period from the date of issuance of the Certificate of Final Acceptance by the Procuring Entity. Specific duration of the warranty is found in the SCC.

8. Liability of the Contractor

Subject to additional provisions, if any, set forth in the SCC, the Contractor's liability under this Contract shall be as provided by the laws of the Republic of the Philippines.

If the Contractor is a joint venture, all partners to the joint venture shall be jointly and severally liable to the Procuring Entity.

9. Termination for Other Causes

Contract termination shall be initiated in case it is determined prima facie by the Procuring Entity that the Contractor has engaged, before, or during the implementation of the contract, in unlawful deeds and behaviors relative to contract acquisition and implementation, such as, but not limited to corrupt, fraudulent, collusive, coercive, and obstructive practices as stated in ITB Clause 4.

10. Dayworks

Subject to the guidelines on Variation Order in Annex "E" of the 2016 revised IRR of RA No. 9184, and if applicable as indicated in the SCC, the Dayworks rates in the Contractor's Bid shall be used for small additional amounts of work only when the Procuring Entity's Representative has given written instructions in advance for additional work to be paid for in that way.

11. Program of Work

- 11.1. The Contractor shall submit to the Procuring Entity's Representative for approval the said Program of Work showing the general methods, arrangements, order, and timing for all the activities in the Works. The submissions of the Program of Work are indicated in the SCC.
- 11.2. The Contractor shall submit to the Procuring Entity's Representative for approval an updated Program of Work at intervals no longer than the period stated in the SCC. If the Contractor does not submit an updated Program of Work within this period, the Procuring Entity's Representative may withhold the amount stated in the SCC from the next payment certificate and continue to withhold this amount until the next payment after the date on which the overdue Program of Work has been submitted.

12. Instructions, Inspections and Audits

The Contractor shall permit the GOP or the Procuring Entity to inspect the Contractor's accounts and records relating to the performance of the Contractor and to have them audited by auditors of the GOP or the Procuring Entity, as may be required.

13. Advance Payment

The Procuring Entity shall, upon a written request of the Contractor which shall be submitted as a Contract document, make an advance payment to the Contractor in an amount not exceeding fifteen percent (15%) of the total contract price, to be made in lump sum, or at the most two installments according to a schedule specified in the SCC, subject to the requirements in Annex "E" of the 2016 revised IRR of RA No. 9184.

14. Progress Payments

The Contractor may submit a request for payment for Work accomplished. Such requests for payment shall be verified and certified by the Procuring Entity's Representative/Project Engineer. Except as otherwise stipulated in the SCC, materials and equipment delivered on the site but not completely put in place shall not be included for payment.

15. Operating and Maintenance Manuals

- 15.1. If required, the Contractor will provide "as built" Drawings and/or operating and maintenance manuals as specified in the SCC.
- 15.2. If the Contractor does not provide the Drawings and/or manuals by the dates stated above, or they do not receive the Procuring Entity's Representative's approval, the Procuring Entity's Representative may withhold the amount stated in the SCC from payments due to the Contractor.

H

SECTION V.

**SPECIAL CONDITIONS
OF CONTRACT**

H

Special Conditions of Contract

GCC Clause	
2	<i>The Intended Completion Date is 100 calendar days upon receipt of the Notice to Proceed.</i>
4.1	<i>The Procuring Entity shall give possession in full the parts of the Site to the Contractor upon receipt of the Notice to Proceed.</i>
6	The site investigation reports are: Site Inspection Report
7.2	<i>[In case of semi-permanent structures, such as buildings of types 1, 2, and 3 as classified under the National Building Code of the Philippines, concrete/asphalt roads, concrete river control, drainage, irrigation lined canals, river landing, deep wells, rock causeway, pedestrian overpass, and other similar semi-permanent structures:] Five (5) years.</i>
10	a. Dayworks are applicable at the rate shown in the Contractor's original Bid.
11.1	"No further instruction."
11.2	"No further instruction."
13	<i>The amount of the advance payment shall not exceed Fifteen Percent (15%) of the total contract price to be recouped every progress billing.</i>
14	Materials and equipment delivered on the site but not completely put in place shall not be included for payment.
15.1	"No further instructions." <i>The date by which "as built" drawings are required is 15 days prior turn-over and acceptance.</i>
15.2	"No further instructions."

H

SECTION VI.

SPECIFICATIONS

[See attached file.]

H

Name of Project

: REPAIR/IMPROVEMENT OF FLOOD CONTROL STRUCTURE

Location

: Sinawilan, Digos City, Davao del Sur

SPECIFICATIONS

<i>Item</i>	<i>Description</i>	<i>Unit</i>	<i>Quantity</i>
B.5	Project Billboard/Signboard	each	2.00
B.7	Occupational Safety and Health	lump sum	1.00
B.9	Mobilization/Demobilization	lump sum	1.00
B.17	Temporary Diversion of waterway	lot	1.00
1501(6)	Rockworks, Class III Rock	cu.m	682.85
101(1)	Removal of Structures and Obstructions	ls	1.00
1700(1)	Clearing & Grubbing	sq.m.	1,162.00
1700(3)	Individual Removal Of Trees	lump sum	1.00
1702(1)a	Structure Excavation (Common Soil)	cu.m.	177.27
1705(1)	Fill and Backfill	cu.m.	96.82
1710(2)a	Grouted Riprap, Class A	cu.m.	106.31
1712(1)	Concrete Slope Protection	cu.m.	243.00

NOTE:

Specifications shall be in accordance with the DPWH Standard Specifications for Public Works Structures (Buildings, Ports and Harbours, Flood Control and Drainage Structures, and Water Supply Systems) Volume III

Prepared by:

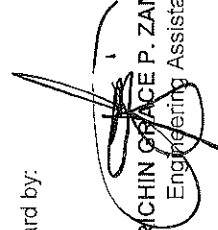
RICHIN GRACE P. ZAMORA
Engineering Assistant

Reviewed by:

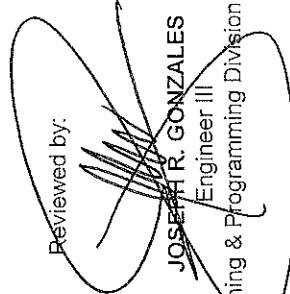
JOSEPH R. GONZALES
Engineer III
Planning & Programming Division Head

Approved by:

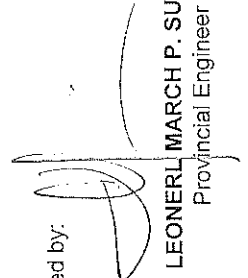
LEONERL MARCH P. SUARIO
Provincial Engineer

SECTION VII.

DRAWINGS

[The Detailed Architectural and Engineering Design is available at the Provincial Government of Davao del Sur, Procurement Management Office, Office of the BAC Secretariat for Infrastructure Projects, Room 16, Executive Building of Provincial Capitol, Mati, Digos City, upon purchase of the corresponding bidding documents.]

H

SECTION VIII.

BILL OF QUANTITIES

[See attached file.]

H

BILL OF QUANTITIES

Contract Name : REPAIR/IMPROVEMENT OF FLOOD CONTROL STRUCTURE
 Location of the Contract : Sinawilan, Digos City, Davao del Sur
 Project Duration : 100 Calendar Days

SUMMARY OF BID PRICES (All Parts of Bill of Quantities)

1. Part No. - Enter the "Part No." for each section of the Bill of Quantities (BOQ) where unit prices are entered.
2. Part Description - Enter the "Part Description" corresponding to the "Part No."
3. Total Amount - Enter the "total amount" in Pesos for all pages having the same "Part Description".
4. Adopting Green Procurement Policy by SBAC Resolution No. 140 series of 2019.

Contract ID:	Part Description	P	Total Amount
B.5	Project Billboard/Signboard	P	
B.7	Occupational Safety and Health	P	
B.9	Mobilization/Demobilization	P	
B.17	Temporary Diversion of waterway	P	
1501(6)	Rockworks, Class III Rock	P	
101(1)	Removal of Structures and Obstructions	P	
1700(1)	Clearing & Grubbing	P	
1700(3)	Individual Removal Of Trees	P	
1702(1)a	Structure Excavation (Common Soil)	P	
1705(1)	Fill and Backfill	P	
1710(2)a	Grouted Riprap, Class A	P	
1712(1)	Concrete Slope Protection	P	
Total of All Amounts		P	
Total of All Amounts in Words:			
PESOS _____ and _____ centavos			

Name : _____ In capacity of _____
 Signed : _____ Date _____

Duly authorized to sign the Bid for and on behalf of _____

Contract Name : REPAIR/IMPROVEMENT OF FLOOD CONTROL STRUCTURE

Location of the Contract : Sinawilan, Digos City, Davao del Sur

Project Duration : 100 Calendar Days

BILL OF QUANTITIES

Part No. _____

Pay Item No.	Description	Unit	Quantity	Unit Price (Pesos)	Amount (Pesos)
1	2	3	4	5	6
B.5	Project Billboard/Signboard	each	2.00	In words: _____ In figures: _____	In words: _____ In figures: _____
B.7	Occupational Safety and Health	lump sum	1.00	In words: _____ In figures: _____	In words: _____ In figures: _____
B.9	Mobilization/Demobilization	lump sum	1.00	In words: _____ In figures: _____	In words: _____ In figures: _____
B.17	Temporary Diversion of Waterway	lot	1.00	In words: _____ In figures: _____	In words: _____ In figures: _____
1501(6)	Rockworks, Class III Rock	cu.m	682.85	In words: _____ In figures: _____	In words: _____ In figures: _____

Submitted by: _____

Date : _____

Name of the Representative of the Bidder _____

Position _____

Name of Bidder _____

Contract Name : REPAIR/IMPROVEMENT OF FLOOD CONTROL STRUCTURE

Location of the Contract : Sinawilan, Digos City, Davao del Sur
 Project Duration : 100 Calendar Days

BILL OF QUANTITIES

Part No. _____

Pay Item No.	Description	Unit	Quantity	Unit Price (Pesos)	Amount (Pesos)
1	2	3	4	5	6
101(1)	Removal of Structures and Obstructions	l.s	1.00	In words: _____ In figures: _____	In words: _____ In figures: _____
1700(1)	Clearing & Grubbing	sq.m.	1162.00	In words: _____ In figures: _____	In words: _____ In figures: _____
1700(3)	Individual Removal Of Trees	lump sum	1.00	In words: _____ In figures: _____	In words: _____ In figures: _____
1702(1)a	Structure Excavation (Common Soil)	cu.m.	177.27	In words: _____ In figures: _____	In words: _____ In figures: _____
1705(1)	Fill and Backfill	cu.m.	96.82	In words: _____ In figures: _____	In words: _____ In figures: _____

Submitted by: _____

Date : _____

Name of the Representative of the Bidder _____

Position _____

Name of Bidder _____

Contract Name : REPAIR/IMPROVEMENT OF FLOOD CONTROL STRUCTURE

Location of the Contract : Sinawilan, Digos City, Davao del Sur

Project Duration : 100 Calendar Days

BILL OF QUANTITIES

Part No. _____

Pay Item No.	Description	Unit	Quantity	Unit Price (Pesos)	Amount (Pesos)
1	2	3	4	5	6
1710(2)a	Grouted Riprap, Class A	cu.m.	106.31	In words: In figures:	In words: In figures:
1712(1)	Concrete Slope Protection	cu.m.	243.00	In words: In figures:	In words: In figures:

Submitted by: _____

Date : _____

Name of the Representative of the Bidder _____

Position _____

Name of Bidder _____

SECTION IX.

CHECKLIST OF TECHNICAL AND FINANCIAL DOCUMENTS

H

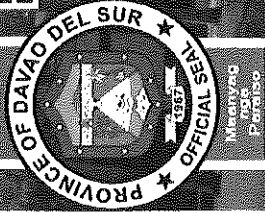

PROCUREMENT MANAGEMENT OFFICE BIDS AND AWARDS COMMITTEE

Mobile Nos. 0905-229-0526/0908-332-2024 (Goods), 0948-768-5848 (Infra)

Telefax: (082) 553-9579

Website: www.davaodelsur.gov.ph/pgo-bac

Email Add.: bac.davaodelsur2@gmail.com/dbac.davaodelsur@gmail.com

Provincia del Sur

CHECKLIST-CIVIL

IB No:

Opening of Bids:

Name of Project/Brief Description of Goods:			
PR:	Dated:	ABC	End User:
Name of Contractor/Supplier:			
Address:			
Contact Number:			
ENVELOPE 1- ELIGIBILITY DOCUMENTS/TECHNICAL			
1. Class "A" Documents			
Legal Documents			
a. Valid PhilGEPS Registration Certificate (Platinum Membership) with its corresponding Annex A.			
Technical Documents			
b. Statement of the prospective bidder of all its on-going government and private contracts, including contracts awarded but not yet started (7 calendar days before the bid opening), if any, whether similar or not similar in nature and complexity to the contract to be bid with supporting documents such as Notice of Award and/or Contract, Notice to Proceed, and Certificate of Accomplishment or Statement of Time Elapsed and Work Accomplished.			
c. Statement of the bidder's Single Largest Completed Contract (SLCC) similar to the contract to be bid for the last (3) years, and whose value, adjusted to current prices using the PSA consumer price indices, must be at least fifty percent (50%) of the ABC to be bid: Provided, however, that contractors under Small A and Small B categories without similar experience on the contract to be bid may be allowed to bid if the cost of such contract is not more than the Allowable Range of Contract Cost (ARCC) of their registration based on the guidelines as prescribed by the PCAB. This Statement must be supported with the following: Contract/ Purchase Order, Certificate of Completion/ Acceptance or Inspection Report or Official Receipt, Validated Contractors/Constructors/ Performance Evaluation System (CPES) in DPWH website.			
d. Valid Philippine Contractors Accreditation Board (PCAB) License or Special PCAB License in case of Joint Ventures, and Registration for the type and cost of the contract to be bid.			
Financial Documents			
e. The prospective bidder's computation of Net Financial Contracting Capacity (NFCC). However, in the case of procurement of Goods, a bidder may submit a committed Line of Credit from a Universal or Commercial Bank, in lieu of its NFCC computation. (Note: K=15)			
2. Class "B" Documents			
a. For Infrastructure Projects, Joint Venture bidders shall submit a Joint Venture Agreement in accordance with R.A. 4566 and its IRR. Each partner of the joint venture shall submit their respective PhilGEPS Certificates of Registration in accordance with Section 8.5.2 of this IRR. The submission of technical and financial eligibility documents by any of the joint venture partners constitutes compliance: Provided, that the partner responsible to submit the NFCC shall likewise submit the Statement of all of its ongoing contracts and Audited Statements.			
TECHNICAL PROPOSAL			
1. Original copy of Bid Security in the form of the following: <input type="checkbox"/> Cash or Cashier's/ Manager's check (2%) <input type="checkbox"/> Bank Guarantee/ Draft or Irrevocable Letter of Credit (2%) <input type="checkbox"/> Surety Bond callable upon demand (5%) <input type="checkbox"/> Bid Securing Declaration (in the prescribed form)			
2. Project Requirements, which shall include the following: a. Organizational chart for the contract to be bid b. List of contractor's personnel (viz., Project Manager, Project Engineers, Materials Engineers, and Foremen), to be assigned to the contract to be bid, with their complete qualifications and experience data;			

K

	<p>c. List of contractor's equipment units, which are owned, leased, and/or under purchase agreements, supported by certification of availability of equipment from the equipment lessor/vendor for the duration of the project;</p>
	<p>3. Original Duly Signed Omnibus Sworn Statement (OSS) by the prospective bidder or its duly authorized representative; and if applicable, Original Notarized Secretary's Certificate in case of a corporation, partnership, or cooperative; or Original Special Power of Attorney of all members of the joint venture giving full power and authority to its officer to sign the OSS and do acts to represent the bidder.</p>
	<p>4. Other documents/materials to comply with other non-discretionary criteria and requirements as stated in the Instruction to Bidders:</p> <ul style="list-style-type: none"> • Construction Methods • Construction schedule and S-Curve • Pert-CPM • Manpower Utilization • Equipment Utilization • Construction Safety & Health Program • Duly Notarized Affidavit of Site Inspection • Duly Notarized Certification as to Compliance to Labor Laws and Standard
	<p>QUALIFIED</p>
	<p>DISQUALIFIED</p>
<p>ENVELOPE 2- FINANCIAL PROPOSAL</p>	
	<p>1. Duly Signed Financial Bid Form</p>
	<p>2. Duly Signed Bid Prices in the Bill of Quantities</p>
	<p>3. Duly Signed Detailed Estimates</p>
	<p>4. Duly Signed Cash Flow by Quarter and Payment Schedules</p>

46

SECTION X.

OTHER DOCUMENTS

- 1) Purchase Request
- 2) Statement of all On-going Government & Private Contracts including
Contracts awarded but not yet started (Prescribed Form)
- 3) Statement of Single Largest Completed Contract (Prescribed Form)
- 4) Bid Securing Declaration (Prescribed Form)
- 5) Omnibus Sworn Statement (Prescribed Form)
- 6) Bid Form (Prescribed Form)
- 7) Resolution No. 861 Series of 2023 / Three-Strike Policy
- 8) Resolution No. 052 Series of 2022
- 9) Resolution No. 053 Series of 2022
- 10) TWG – Checklist for Bid Evaluation
- 11) TWG – Checklist for Post Qualification

fi

PURCHASE REQUEST

PROVINCE OF DAVAO DEL SUR

MATTI, DIGOS CITY

PR NO. : 136-23-5 Date : 09-05-23
 SAI NO. : _____ Date : _____

Department : PROVINCIAL ENGINEER'S OFFICE
 Section : Construction

STOCK No.	UNIT OF ISSUE	ITEM DESCRIPTION	QTY	UNIT COST	TOTAL COST
1	Job Order	REPAIR/ IMPROVEMENT OF FLOOD CONTROL STRUCTURE located at SINAWILAN, DIGOS CITY, DAVAO DEL SUR all in accordance, to plans, specifications and scope of work and the Green Procurement Policy as adopted by Executive Order No. 30 series of 2019. XXXXXXXXXXXXXXXX TOTAL	1	₱	6,000,000.00 wwwww
TECHNICAL WORKING GROUP TECHNICAL SPECS CONTROLLED BY: <i>[Signature]</i> DATE: <i>09/05/23</i>					
Charge to: <u>Repair/ Improvement of Flood Control Structure</u> <u>Sinawilan, Digos City, Davao del Sur</u> <u>CY 2023 - 5% Calamity Fund</u> <u>9943-04 Flood Control System 1-07-03-020</u>					
Purpose/Remarks: <u>For use in the REPAIR/ IMPROVEMENT OF FLOOD CONTROL STRUCTURE</u> <u>located at SINAWILAN, DIGOS CITY, DAVAO DEL SUR</u>					
APPROVED: <i>[Signature]</i> YVONNE ROSA CAGAS Governor					
CASH AVAILABILITY: <i>[Signature]</i> FARAH GEMMA V. BIDAN, CPA Provincial Treasurer					
Signature: <i>[Signature]</i> LEONERL MARCH P. SUARIO Provincial Engineer					
Date: <u>August 24, 2023</u>					

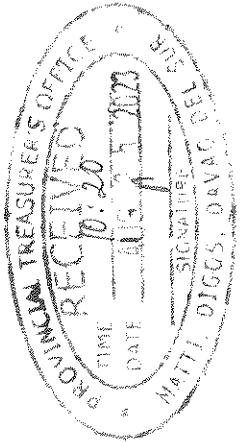

Bid Securing Declaration Form

[shall be submitted with the Bid if bidder opts to provide this form of bid security]

REPUBLIC OF THE PHILIPPINES)
CITY OF _____) S.S.

BID SECURING DECLARATION
Project Identification No.: [Insert number]

To: *[Insert name and address of the Procuring Entity]*

I/We, the undersigned, declare that:

1. I/We understand that, according to your conditions, bids must be supported by a Bid Security, which may be in the form of a Bid Securing Declaration.
2. I/We accept that: (a) I/we will be automatically disqualified from bidding for any procurement contract with any procuring entity for a period of two (2) years upon receipt of your Blacklisting Order; and, (b) I/we will pay the applicable fine provided under Section 6 of the Guidelines on the Use of Bid Securing Declaration, within fifteen (15) days from receipt of the written demand by the procuring entity for the commission of acts resulting to the enforcement of the bid securing declaration under Sections 23.1(b), 34.2, 40.1 and 69.1, except 69.1(f), of the IRR of RA No. 9184; without prejudice to other legal action the government may undertake.
3. I/We understand that this Bid Securing Declaration shall cease to be valid on the following circumstances:
 - a. Upon expiration of the bid validity period, or any extension thereof pursuant to your request;
 - b. I am/we are declared ineligible or post-disqualified upon receipt of your notice to such effect, and (i) I/we failed to timely file a request for reconsideration or (ii) I/we filed a waiver to avail of said right; and
 - c. I am/we are declared the bidder with the Lowest Calculated Responsive Bid, and I/we have furnished the performance security and signed the Contract.

IN WITNESS WHEREOF, I/We have hereunto set my/our hand/s this ____ day of [month] [year] at [place of execution].

*[Insert NAME OF BIDDER OR ITS AUTHORIZED
REPRESENTATIVE]
[Insert signatory's legal capacity]
Affiant*

[Jurat]

[Format shall be based on the latest Rules on Notarial Practice]

Omnibus Sworn Statement (Revised)

[shall be submitted with the Bid]

REPUBLIC OF THE PHILIPPINES)
CITY/MUNICIPALITY OF _____) S.S.

AFFIDAVIT

I, [Name of Affiant], of legal age, [Civil Status], [Nationality], and residing at [Address of Affiant], after having been duly sworn in accordance with law, do hereby depose and state that:

1. *[Select one, delete the other:]*

[[If a sole proprietorship:] I am the sole proprietor or authorized representative of [Name of Bidder] with office address at [address of Bidder];

[[If a partnership, corporation, cooperative, or joint venture:] I am the duly authorized and designated representative of [Name of Bidder] with office address at [address of Bidder];

2. *[Select one, delete the other:]*

[[If a sole proprietorship:] As the owner and sole proprietor, or authorized representative of [Name of Bidder]. I have full power and authority to do, execute and perform any and all acts necessary to participate, submit the bid, and to sign and execute the ensuing contract for [Name of the Project] of the [Name of the Procuring Entity], as shown in the attached duly notarized Special Power of Attorney;

[[If a partnership, corporation, cooperative, or joint venture:] I am granted full power and authority to do, execute and perform any and all acts necessary to participate, submit the bid, and to sign and execute the ensuing contract for [Name of the Project] of the [Name of the Procuring Entity], as shown in the attached [state title of attached document showing proof of authorization (e.g., duly notarized Secretary's Certificate, Board/Partnership Resolution, or Special Power of Attorney, whichever is applicable)];

3. [Name of Bidder] is not "blacklisted" or barred from bidding by the Government of the Philippines or any of its agencies, offices, corporations, or Local Government Units, foreign government/foreign or international financing institution whose blacklisting rules have been recognized by the Government Procurement Policy Board, by itself or by relation, membership, association, affiliation, or controlling interest with another blacklisted person or entity as defined and provided for in the Uniform Guidelines on Blacklisting.

4. Each of the documents submitted in satisfaction of the bidding requirements is an authentic copy of the original, complete, and all statements and information provided therein are true and correct;

5. [Name of Bidder] is authorizing the Head of the Procuring Entity or its duly authorized representative(s) to verify all the documents submitted;

6. *[Select one, delete the rest:]*

[[If a sole proprietorship:] The owner or sole proprietor is not related to the Head of the Procuring Entity, members of the Bids and Awards Committee (BAC), the Technical

Working Group, and the BAC Secretariat, the head of the Project Management Office or the end-user unit, and the project consultants by consanguinity or affinity up to the third civil degree;

[If a partnership or cooperative:] None of the officers and members of *[Name of Bidder]* is related to the Head of the Procuring Entity, members of the Bids and Awards Committee (BAC), the Technical Working Group, and the BAC Secretariat, the head of the Project Management Office or the end-user unit, and the project consultants by consanguinity or affinity up to the third civil degree;

[If a corporation or joint venture:] None of the officers, directors, and controlling stockholders of *[Name of Bidder]* is related to the Head of the Procuring Entity, members of the Bids and Awards Committee (BAC), the Technical Working Group, and the BAC Secretariat, the head of the Project Management Office or the end-user unit, and the project consultants by consanguinity or affinity up to the third civil degree;

7. *[Name of Bidder]* complies with existing labor laws and standards; and
8. *[Name of Bidder]* is aware of and has undertaken the responsibilities as a Bidder in compliance with the Philippine Bidding Documents, which includes:
 - a. Carefully examining all of the Bidding Documents;
 - b. Acknowledging all conditions, local or otherwise, affecting the implementation of the Contract;
 - c. Making an estimate of the facilities available and needed for the contract to be bid, if any; and
 - d. Inquiring or securing Supplemental/Bid Bulletin(s) issued for the *[Name of the Project]*.
9. *[Name of Bidder]* did not give or pay directly or indirectly, any commission, amount, fee, or any form of consideration, pecuniary or otherwise, to any person or official, personnel or representative of the government in relation to any procurement project or activity.
10. In case advance payment was made or given, failure to perform or deliver any of the obligations and undertakings in the contract shall be sufficient grounds to constitute criminal liability for Swindling (Estafa) or the commission of fraud with unfaithfulness or abuse of confidence through misappropriating or converting any payment received by a person or entity under an obligation involving the duty to deliver certain goods or services, to the prejudice of the public and the government of the Philippines pursuant to Article 315 of Act No. 3815 s. 1930, as amended, or the Revised Penal Code.

IN WITNESS WHEREOF, I have hereunto set my hand this ___ day of ___, 20__ at _____, Philippines.

[Insert NAME OF BIDDER OR ITS AUTHORIZED REPRESENTATIVE]
[Insert signatory's legal capacity]
Affiant

[Jurati]
[Format shall be based on the latest Rules on Notarial Practice]

Bid Form for the Procurement of Infrastructure Projects

[shall be submitted with the Bid]

BID FORM

Project Identification No. : _____

Date : _____

To: *[name and address of Procuring Entity]*

Having examined the Philippine Bidding Documents (PBDs) including the Supplemental or Bid Bulletin Numbers *[insert numbers]*, the receipt of which is hereby duly acknowledged, we, the undersigned, declare that:

- a. We have no reservation to the PBDs, including the Supplemental or Bid Bulletins, for the Procurement Project: *[insert name of contract]*;
- b. We offer to execute the Works for this Contract in accordance with the PBDs;
- c. The total price of our Bid in words and figures, excluding any discounts offered below is: *[insert information]*;
- d. The discounts offered and the methodology for their application are: *[insert information]*;
- e. The total bid price includes the cost of all taxes, such as, but not limited to: *[specify the applicable taxes, e.g. (i) value added tax (VAT), (ii) income tax, (iii) local taxes, and (iv) other fiscal levies and duties]*, which are itemized herein and reflected in the detailed estimates.
- f. Our Bid shall be valid within the a period stated in the PBDs, and it shall remain binding upon us at any time before the expiration of that period;
- g. If our Bid is accepted, we commit to obtain a Performance Security in the amount of *[insert percentage amount]* percent of the Contract Price for the due performance of the Contract, or a Performance Securing Declaration in lieu of the allowable forms of Performance Security, subject to the terms and conditions of issued GPPB guidelines¹ for this purpose;
- h. We are not participating, as Bidders, in more than one Bid in this bidding process, other than alternative offers in accordance with the Bidding Documents;
- i. We understand that this Bid, together with your written acceptance thereof included in your notification of award, shall constitute a binding contract between us, until a formal Contract is prepared and executed; and
- j. We understand that you are not bound to accept the Lowest Calculated Bid or any other Bid that you may receive.
- k. We likewise certify/confirm that the undersigned, is the duly authorized

¹ currently based on GPPB Resolution No. 09-2020

representative of the bidder, and granted full power and authority to do, execute and perform any and all acts necessary to participate, submit the bid, and to sign and execute the ensuing contract for the [Name of Project] of the [Name of the Procuring Entity].

- I. We acknowledge that failure to sign each and every page of this Bid Form, including the Bill of Quantities, shall be a ground for the rejection of our bid.

Name: _____

Legal Capacity: _____

Signature: _____

Duly authorized to sign the Bid for and behalf of: _____

Date: _____

1299

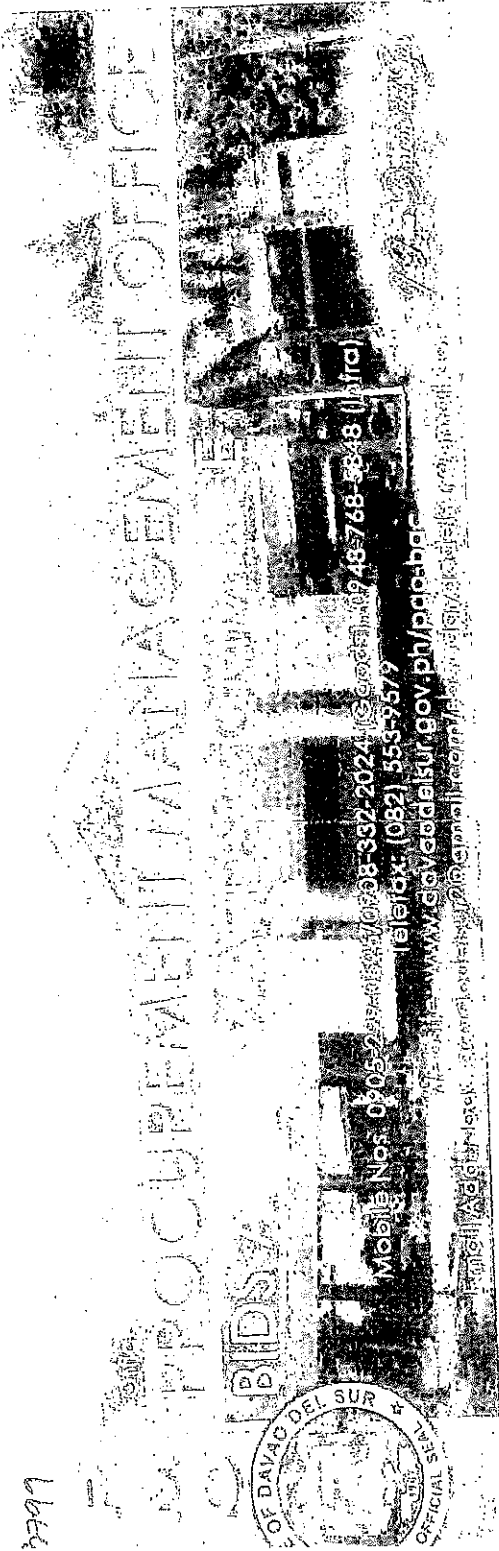

Resolution No. 861
Series of 2023

**A RESOLUTION
RECOMMENDING TO THE HEAD OF THE PROCURING ENTITY, GOVERNOR
YVONNE RONÁ CAGAS TO ADOPT THE AMENDED 3-STRIKE POLICY IN THE
PROCUREMENT OF CONTRACTS FOR GOODS AND SERVICES, AND
INFRASTRUCTURE PROJECTS OF THE PROVINCIAL GOVERNMENT OF DAVAO
DEL SUR.**

WHEREAS, the Provincial Government of Davao del Sur encounters several failures of biddings due to constant errors committed by the participating Bidders in the submission of their bidding documents despite of the orientation during Pre-Bid Conference and the Instruction to Bidders;

WHEREAS, to further strengthen the integrity of the competitive bidding process, the Bids and Awards Committee unanimously agreed that the following instructions are hereby issued pertaining to the implementation of the 3-Strike Policy of the Provincial Government of Davao del Sur against violations of Section 69 of the IRR of RA 9184;

1. The provision of Section 69.1 of the said IRR, pertaining to the 3-Strike Policy of the Provincial Government of Davao del Sur, is hereby reiterated as follows:
 "In addition to the provisions of Rules XXI and XXII of this IRR, the Head of the Procuring Entity, subject to the authority delegated to the BAC, if any, shall impose on bidders or prospective bidders, the administrative penalty of suspension for one (1) year for the first offense, and suspension of two (2) years for the second offense from participating in the competitive bidding process, as well as disqualification from further participating in the competitive bidding being undertaken by the Procuring Entity concerned, where applicable, for the following violations: 69.1.1 All other acts that tend to defeat the purpose of the competitive bidding, such as habitually withdrawing from bidding, submitting late Bids or patently insufficient bid, for at least three (3) times within a year, except for valid reasons."
2. The violations enumerated, which are considered as acts that tend to defeat the purpose of competitive bidding, are hereby clarified to read as follows:
 - a) Non-submission of post-qualification and other requirements within the prescribed period as specified in the notice issued by the BAC;
 - b) Submission of eligibility requirements containing false information or falsified documents.
 - c) Submission of Bids that contain false information or falsified documents, or the concealment of such information in the Bids in order to influence the outcome of eligibility screening, or any other stage of the competitive bidding.

DAVAO DEL SUR

H

✓

- d) Allowing the use of one's name, or using the name of another for purposes of competitive bidding.
 - e) Refusal to accept an award, or enter into contract with the Government without justifiable cause, after he had been adjudged as having submitted the Lowest Calculated Responsive Bid or Highest Rated Responsive Bid.
 - f) Refusal or failure to post the required performance security within the prescribed time
 - g) Termination of the contract due to the default of the bidder
 - h) Refusal to clarify or validate in writing its bid during post-qualification and site validation within a period of seven (7) calendar days from receipt of the request for clarification.
 - i) Any documented attempt by a bidder to unduly influence the outcome of the bidding in his favor.
 - j) Refusal to deliver items stipulated in the Purchase Order without justifiable cause, despite receiving the said Purchase Order and despite issuance of demand letter to deliver
 - k) All other acts that tend to defeat the purpose of competitive bidding, such as:
 - 1.) Withdrawing from bidding or Non-dropping of Bid Documents,
 - 2.) Submitting late Bids;
 - 3.) Submitting of patently insufficient bid. Patently insufficient bid is clarified as the "total absence" of the required document.
 - 4.) Refusal to receive/acknowledge notice/s issued by the Head of the Procuring Entity and/or Bids and Awards Committee
 - l) Habitually committing offenses that are not grounds for disqualification such as improper sealing, non-tabling, and the like.
3. Every time a bidder is observed to have done any of the acts enumerated under Item 2 of this Resolution, the Chairperson of the BAC shall immediately issue a Show Cause Order to the erring bidder informing him of his act, and giving him three (3) calendar days to show cause why he should not be sanctioned for committing an act which tends to defeat the purpose of public bidding under the 3-Strike Policy of the Provincial Government of Davao del Sur;
4. Based on the evaluation by the BAC of the bidder's response to the Show Cause Order mentioned in Item No. 3 of this Resolution, the BAC shall, within five (5) calendar days from the receipt of the bidder's response determine whether the bidder's act was done with or without a valid cause;
5. The BAC Secretariat shall submit to the BAC a 3-Strike Policy Report, which shall contain the information in Item 3 and 9 of this Resolution.

h

6. The BAC through its Secretariat shall monitor the participation of bidders in all of its projects/participations, and maintain a tally of violations by each bidder of the 3-Strike Policy in its jurisdiction as well as of the violations by the bidder of the said policy in other offices of the Provincial Government of Davao del Sur.
7. All other petty defects found in the bid documents of the bidder which will not redound to defeat the purpose of Competitive Bidding shall not be a ground for the imposition of a strike, subject to the discretion of the BAC
8. For the procurement of Infrastructure Projects, this Policy is applicable to all methods of procurement, be it Competitive Bidding or alternative methods of procurement. For the procurement of Goods and Consulting Services, this Policy is applicable to Competitive Bidding only, except for the following which shall also be applicable to Procurement Contracts for Goods and Services under Alternative Methods of Procurement
 - 2.e Refusal to accept an award, or enter into contract with the Government without justifiable cause, after he had been adjudged as having submitted the Lowest Calculated Responsive Bid or Highest Rated Responsive Bid.
 - 2.g Termination of the contract due to the default of the bidder
 - 2.j Refusal to deliver items stipulated in the Purchase Order without justifiable cause, despite receiving the said Purchase Order and despite issuance of demand letter to deliver
9. For the sanctions to be imposed:
 - o **ONE (1) STRIKE** will be imposed for various IB Nos. participated by the bidder with the same nature of violation opened on the same date, or was disqualified during post-qualification stage with the same case of the latter;
 - o **MULTIPLE STRIKES** for different discrepancies/offenses under different IB Nos. opened on the same date, or was disqualified during post-qualification stage with the same case of the latter;
 - o For Item 2.1: Three habitual offenses are equivalent to one (1) strike
10. Each "offense" by a bidder referred to in Section 69.1.1. of the IRR, as stated in this Resolution, consists of three violations or strikes within a period of one calendar year for all the procurements of all offices of the Provincial Government of Davao del Sur. A Fresh Period of one (1) year in counting of "strikes" shall be observed in the succeeding year;
11. Based on the 3-Strike reports, the Bids and Awards Committee, shall recommend to the Head of the Procuring Entity, for approval, the following administrative sanctions on the erring Contractor/Supplier for the violation of the 3-Strike Policy.

h8

A

- a. For the first violation or strike – a first warning.
- b. For the second strike – a second warning.
- c. For the third strike, which together with the first two strikes constitutes the first offense against the 3-Strike Policy – an administrative penalty of suspension for one (1) year from participating in any procurement process in the Provincial Government of Davao del Sur.
- d. For the second offense – the second set of three strikes committed by the bidder – an administrative suspension for two (2) years from participating in any procurement process in the Provincial Government of Davao del Sur.

WHEREFORE, on motion of BAC Member, Dominic S. Bucol, JD duly seconded by all BAC Members present it was –

RESOLVED, as it is hereby RESOLVED, to recommend to the Head of the Procuring Entity, GOVERNOR YVONNE ROÑA CAGAS to ADOPT THE AMENDED 3-STRIKE POLICY IN THE PROCUREMENT OF CONTRACTS FOR GOODS AND SERVICES, AND INFRASTRUCTURE PROJECTS OF THE PROVINCIAL GOVERNMENT OF DAVAO DEL SUR.

RESOLVED FINALLY, to furnish copies of this Resolution to all agencies concerned, Suppliers, and Concerned End Users, for their information and guidance.

UNANIMOUSLY APPROVED at the Ralota Hall, Governor Douglas Ralota Cagas Sports and Business Complex, Barangay Matti, Digos City, Province of Davao del Sur, this 15th day of June, 2023.

fs

✓

I hereby concur to the correctness of the minutes:



ENGR. SHIELA M. A. ZAPANTA, MPA
Administrative Officer IV, PMO
Head, BAC Secretariat for Infrastructure Projects



NORJANINA M. CAMAGUIN, MPA
Chief Administrative Officer, PMO
Head, BAC Secretariat for Goods and Consulting Services

(ON LEAVE)
ENGR. RODERICK MILANA, REA
Provincial Assessor / BAC Member

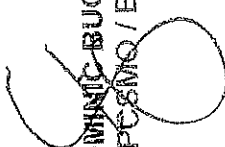
ALLAN C. PUTONG, JD
PGDH-PCSMO / BAC Member

ENGR. ANGELIE R. GELLA
APGDH-PEO / BAC Member

DOMINIC BUCOL, JD
PGDH-PCSMO / BAC Member



RAUL R. FUECONCILLO,
LAgri.Mag.Dev.
Provincial Agriculturist / BAC Member

RAUL D. RAUT, ENP, JD
PGDH-PHRMO / BAC Vice-Chairperson

DESSAMIE BUAT-SANCHEZ, CPA, JD
PGDH-PBO / BAC Chairperson
Presiding Officer

Approved by:

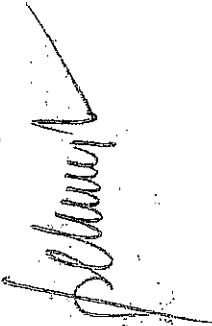
YVONNE ROÑA CAGAS
Governor
Head of Procuring Entity





Republic of the Philippines
PROVINCE OF DAVAO DEL SUR
Barangay Matti, Digos City, Davao del Sur
Municipal Office
Mobile No. (081) 226-2333; Website: www.davaodelsur.gov.ph
Telephone: (081) 226-9150; Website: www.davaodelsur.gov.ph
Telefax: (081) 226-9150; Website: www.davaodelsur.gov.ph
E-mail: dcdavaodelsur2@proffil.com; dcdavaodelsur@gmail.com

OFFICE OF THE GOVERNOR
BIDS AND AWARDS COMMITTEE (BAC)

Resolution No. 052
Series of 2022

**A RESOLUTION
RECOMMENDING TO THE HEAD OF THE PROCURING ENTITY, GOVERNOR
YVONNE ROÑA CAGAS TO ADOPT THE SUSPENSION OF PARTICIPATING
BIDDERS WHO WILL INCUR ANY OF THE VIOLATIONS STIPULATED IN SECTION
41 OF THE 2016 REVISED IMPLEMENTING RULES AND REGULATIONS OF
REPUBLIC ACT NO. 9184, OTHERWISE KNOWN AS THE GOVERNMENT
PROCUREMENT REFORM ACT.**

WHEREAS, the Provincial Government of Davao del Sur encounters failures of biddings due to constant violations committed by the participating Bidders in the submission of their bidding documents despite of the orientation during Pre-bid Conference and the Instruction to Bidders;

WHEREAS, to further strengthen the integrity of the competitive bidding process, the Bids and Awards Committee together with the Members of the Technical Working Group unanimously agreed that the following instructions are hereby issued pertaining to the implementation of the Suspension of the Participating Bidders against violations of Section 41 of the Revised IRR of RA 9184;

1. The provision of Section 41 the Revised IRR of RA 9184 is hereby reiterated as follows:

"Section 41. Reservation Clause. - The Head of the Agency reserves the right to reject any and all Bids, declare a failure of bidding, or not award the contract in the following situations:

- a. If there is prima facie evidence of collusion between appropriate public officers or employees of the Procuring Entity, or between the BAC and any of the bidders, or if the collusion is between or among the bidders themselves, or between a bidder and a third party, including any act which restricts, suppresses or nullifies or tends to restrict, suppress or nullify competition;*
 - b. If the BAC is found to have failed in following the prescribed bidding procedures; or*
 - c. For any justifiable and reasonable ground where the award of the contract will not redound to the benefit of the government as defined in the IRR."*
2. The violations enumerated, which are considered as acts that tend to defeat the purpose of competitive bidding, are hereby clarified to read as follows:
- 2.a. If there is prima facie evidence of collusion between appropriate public officers or employees of the Procuring Entity*
 - 2.b. If there is prima facie evidence of collusion between the BAC and any of the bidders;*

h



Republic of the Philippines

PROVINCE OF DAVAO DEL SUR

Barangay Matti, Digos City, Davao del Sur

Mobile No: 0939-990-0664/1838-32-3024/0948-763-9348

Telefax: (082) 000-1951; 0939-990-0664; 0939-990-0664; 0939-990-0664

... ..

OFFICE OF THE BAC

CHDS AN DAVAO DEL SUR

BAC Resolution No. 052 s. 2022

Page -2-

x-x-x-x-x-x-x-x-x-x-x-x-x-x-x-x-x-x-x

- 2.c *If there is prima facie evidence of collusion between or among the bidders themselves, or between a bidder and a third party, including any act which restricts, suppresses or nullifies or tends to restrict, suppress or nullify competition;*
3. The BAC through its Secretariat shall monitor the participation of bidders in all of its projects and maintain a tally of violations by each bidder in its jurisdiction as well as of the violations by the bidder of the said policy in other offices of the Provincial Government of Davao del Sur.

4. The Bids and Awards Committee, shall recommend to the Head of the Procuring Entity, for approval, the administrative sanction on the erring participating bidder/contractor for the violation Section 41 of RA 9184:
 - a. For the first violation – an administrative penalty of suspension for three (3) months from participating in any procurement process in the Provincial Government of Davao del Sur.
 - b. For the second violation – an administrative penalty of suspension for one (1) year from participating in any procurement process in the Provincial Government of Davao del Sur.
 - c. For the third offense- perpetual disqualification from participating in any procurement process in the Provincial Government of Davao del Sur.

WHEREFORE, on motion of BAC Member Milana, duly seconded by BAC Member Putong, it was –

RESOLVED, as it is hereby **RESOLVED**, to recommend to the Head of the Procuring Entity, **GOVERNOR YVONNE ROÑA CAGAS to ADOPT THE SUSPENSION OF PARTICIPATING BIDDERS WHO WILL INCUR ANY OF THE VIOLATIONS STIPULATED IN SECTION 41 OF THE 2016 REVISED IMPLEMENTING RULES AND REGULATIONS OF REPUBLIC ACT NO. 9184, OTHERWISE KNOWN AS THE GOVERNMENT PROCUREMENT REFORM ACT.**

RESOLVED FINALLY, to furnish copies of this Resolution to all agencies concerned for their information and guidance.

UNANIMOUSLY APPROVED at the Almendras Hall, Governor Douglas Ralota Cagas Sports and Business Complex, Barangay Matti, Digos City, Province of Davao del Sur, this 14th day of July, 2022.

I hereby certify the correctness of above-mentioned resolution.

Engr. **SHIELA MAE ZAPANTA, MPA**
Agricultural Technologist
Head, BAC Secretariat (Infrastructure Projects)

NORJANNA M. CAMAGUIN, MPA
LTOO IV
Head, BAC Secretariat (Goods and Consulting Services)



Republic of the Philippines
PROVINCE OF DAVAO DEL SUR
 Barangay Matti, Digos City, Davao del Sur
 Mobile No: 0904-299-0536 / 0918-512-2624 / 0908-765-5848
 Telefax: (082) 553-9579 / Website: www.davaodelsur.gov.ph
 E-mail Add.: bac.davao@dsd24.gov.ph, sbac.davaodelsur@gmail.com

OFFICE OF THE GOVERNOR

PROVINCE OF DAVAO DEL SUR

BAC Resolution No. 052 s. 2022

Page -3-

X-X-X-X-X-X-X-X-X-X-X-X-X-X-X-X

Attested by:

DOMINIC S. BUCOL JD
 PGDH-Provincial Warden Office
 BAC Member

(on leave)
RAUL R. FUECONCILLO, MagDev
 PGDH-OPAG
 BAC Member

Engr. ANGELIER R. GELLA
 APGDH-PEO
 BAC Member

Engr. RODERICK R. MILANA, REA
 PGDH-PASSO
 BAC Member

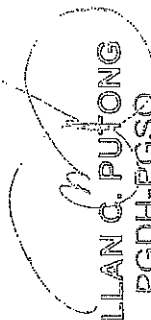
ALLAN C. PUTONG
 PGDH-PGSO
 BAC Member

RAUL B. RAUT, EnP, JD
 PGDH-HRMO
 BAC Vice Chairperson

DESSAMIE BUAT-SANCHEZ, CPA, JD
 Provincial Budget Officer
 BAC Chairperson – Presiding Officer

Approved by:

YVONNE RONA CAGAS
 Governor
 Head of Procuring Entity

Resolution No. 053
Series of 2022

A RESOLUTION

RECOMMENDING TO THE HEAD OF THE PROCURING ENTITY, GOVERNOR YVONNE ROÑA CAGAS, TO DECLARE BIDDERS WHO FAILED TO DISCLOSE ALL ON-GOING PROJECTS AS DISQUALIFIED, AFTER FINDING SUCH NON-INCLUSION DURING POST-QUALIFICATION OF BIDDERS BY THE BAC TECHNICAL WORKING GROUP (TWG).

Be it enacted by the BAC MEMBERS in meeting assembled:

WHEREAS, in line with the Provincial Government of Davao del Sur's initiative to fast-track the procurement transactions of the Province, the Special Bids and Awards Committee hereby adopts this Resolution to produce Contractors with integrity and truthfulness in their submitted bid;

WHEREAS, item number 2 of GPPB NPM 111-2013 states that, "*Failure to include all on-going and completed contracts in the Statement may be a ground for disqualification for being incomplete, and may also result in blacklisting if proven that such failure amounts to submission of false information or false documents. The submission of the eligibility documents enumerated in Section 23.1 of the IRR is a mandatory requirement that must be complied with by prospective bidders, such that failure to submit any of the documents or the submission of an otherwise incomplete or patently insufficient document, will disqualify the bidder based on the non-discretionary "pass/fail" criterion under Section 30.1 of the IRR.*"

IN ADDITION, GPPB NPM 006-2018 states that, "*Failure to declare an on-going government and private contract, including contracts awarded but not yet started, if any, whether similar or not similar in nature and complexity to the contract to be bid is a ground for disqualification. These contracts, as reflected in the "Statement of all on-going contracts", are vital to the computation of the Net Financial Contracting Capacity of the bidder, and they are necessary information during the post-qualification stage to verify, validate and ascertain the technical qualification of the Lowest Calculated Bidder for the ultimate determination whether it is the Lowest Calculated and Responsive Bidder.*"

WHEREFORE, after thorough deliberation, BAC Member Milana duly seconded by BAC Member Putong, it was-

RESOLVED, as it is hereby **RESOLVED**, to recommend to the **HEAD OF PROCURING ENTITY, GOVERNOR YVONNE ROÑA CAGAS, TO DECLARE BIDDERS WHO FAILED TO DISCLOSE ALL ON-GOING PROJECTS AS DISQUALIFIED AFTER FINDING SUCH NON-INCLUSION DURING POST-QUALIFICATION OF BIDDERS BY THE BAC TECHNICAL WORKING GROUP (TWG)**;

RESOLVED FINALLY, to furnish copies of this Resolution to all agencies concerned for their information and guidance.

UNANIMOUSLY APPROVED at the Almendras Hall, Governor Douglas Ralota Cagas Sports and Business Complex, Barangay Matti, Digos City, Province of Davao del Sur, this 14th day of July, 2022.

I hereby certify to the correctness of above-mentioned resolution

ENGR. SHEILA MAE ZAPANTA, MPA
 Agricultural Technologist
 Head, BAC Secretariat (Infrastructure Projects)



NORJANNA M. CAMAGUIN, MPA
 LTOO IV
 Head, BAC Secretariat (Goods and Consulting Services)

Attested by:

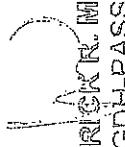

DOMINIC S. BUCOL JD
PGDH-Provincial Warden Office
BAC Member

(on leave)
RAUL R. FUECONCILLO, MagDev
PGDH-Office of the Provincial Agriculturist
BAC Member

ENGR. ANGELIE R. GELLA
APGDH-PEO
BAC Member

ENGR. RODRICK R. MILANA, REA
PGDH-PASSO
BAC Member

ALLAN C. PUTONG, JD
PGDH-PGSO
BAC Member

RAUL D. RAUT, EnP, JD
PGDH-HRMO
BAC Vice Chairperson

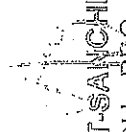
DESSAMIE BUAT-SANCHEZ, CPA, JD
PGDH - PBO
BAC Chairperson – Presiding Officer

Approved by:

YVONNE RONA GAGAS
Governor
Head of Procuring Entity



PROCUREMENT MANAGEMENT OFFICE BIDS AND AWARDS COMMITTEE

Mobile Nos. 0905-229-0526/0908-332-2024 (Goods) 0948-768-5848 (Info)

Telefax: (082) 553-9579

Website: www.davaodelsur.gov.ph/pgg-bac

Email Add.: bac.davaodelsur@gmail.com/sbaedavodelsur@gmail.com

Of Love Davao del Sur

TWG – CHECKLIST FOR BID EVALUATION

IB No.	Name of Project:	FINDINGS	REMARKS
	Contractor:		
	ITEMS:		
	1. Bid Amount (both in words and in figure) must be below ABC.		
	2. Bill of Quantities submitted by the contractor must conform with the Bill of Quantities issued by the End-User.		
	3. Detailed Estimates		
	A. Check mathematical computation in the Detailed Estimates		
	B. The amount in the Detailed Estimates must be reconciled with the amount in the summary of bid and the quantities in the BOQ.		
	C. Allowance for waste and/or losses, not to exceed 5% of materials equipment.		
	D. Mobilization and demobilization shall not exceed 1% of the Estimated Direct Cost (EDC) of the civil works items.		
	E. Overhead expenses must be within the range of %-11% of the EDC.		
	F. Contingencies must be within the range of 0.5%-3% of the EDC.		
	G. Miscellaneous expenses must be within the range of 0.5%-1% of the EDC.		
	H. Contractor's Profit Margin shall be 8% of the EDC for projects above 5 million and 10% for the projects 5 million and below.		
	I. VAT Component shall be 5% of the sum of the EDC, OCM, and Profit.		
	J. The following non-civil work items shall not be subjected to OCM mark-up:		
	1. Field/ Laboratory Office & Living Quarters (Rental Basis)		
	2. Furnishing of Furniture, Laboratory Equipment, Survey Equipment and Consumables		
	3. Assistance to the Engineers		
	4. Photographs		
	5. Health and Safety		
	2. Traffic Management		
	3. Environmental Compliance		
	4. Communication Equipment		
	5. Project Billboard, etc.		



PROCUREMENT MANAGEMENT OFFICE BIDS AND AWARDS COMMITTEE

Mobile Nos. 0905-229-0526/0908-332-2024 (Goods), 0948-768-5848 (Infra)
Telefax: (082) 553-9579

Website: www.davaodelsur.gov.ph/pgo-bac

Email Add.: bac-davaodelsur2@gmail.com/sbaedavaodelsur@gmail.com



<p>K. The following items shall not be subjected to OCM and Profit mark-up:</p>													
<p>A. Mobilization and demobilization</p>													
<p>B. Provision of Service Vehicle</p>													
<p>C. Permits and Clearances</p>													
<p>4. Bid Security</p>													
<p>A. Cash or Cashier's/ Manager's check (2%)</p>													
<p>B. Bank Guarantee/ Draft or Irrevocable Letter of Credit (2%)</p>													
<p>C. Surety Bond callable upon demand (5%)</p>													
<p>D. Bid Securing Declaration (must be in prescribed form, 15 days)</p>													
<p>E. Cash Flow by quarter and payment schedule (check mathematical computation against the bid amount)</p>													



PROCUREMENT MANAGEMENT OFFICE BIDS AND AWARDS COMMITTEE

Mobile Nos. 0905-229-0526/0908-332-2024 (Goods), 0948-768-5848 (Infra)
Telefax: (082) 553-9579

Website: www.davaodelsur.gov.ph/pgo-bac

Email Add.: bac.davaodelsur@gmail.com/sbacdavaodelsur@gmail.com

I Love Davao del Sur

TWG – CHECKLIST FOR POST QUALIFICATION

IB. No.	Name of Project:	FINDINGS	REMARKS
	Contractor:		
	TECHNICAL DOCUMENTS:		
	1. Not a Blacklisted Contractor per GPPB Website		
	2. Registration certificate from SEC, Department of Trade and Industry (DTI) for sole proprietorship, or CDA for cooperatives must be valid (Company Name and Validity)		
	3. Mayor's/ Business permit must be valid (Company Name and Validity)		
	4. Tax Clearance must be valid (Company Name and Validity)		
	5. PhilGEPS Registration (Platinum Membership) must be valid (Company Name and Validity)		
	6. Valid Philippine Contractors Accreditation Board or Special PCAB License in case of Joint Ventures (PCAB)		
	7. Statement of all on-going government and private contracts including awarded but not yet started		
	A. Complete attachments		
	I. Notice of Award		
	II. Contract		
	III. Notice to Proceed		
	IV. Contract Extension, if any;		
	V. Statement of Work Accomplishment duly signed by the Procuring Entity		
	B. Evaluate the projects, if any:		
	i. Verify Target Date of Completion		
	ii. Must not incur Negative Slippage of more than fifteen percent (15%) in any one project or a negative slippage of more than ten percent (10%) in each two (2) or more contracts.		
	C. Verification of on-going projects via DPWH portal		
	8. Statement of the bidder's Single Largest Completed Contract (SLCC) similar to the contract to be bid for the last (3) years, and whose value, adjusted to current prices using the PSA consumer price indices, must be at least fifty percent (50%) of the ABC to be bid: Provided, however, that contractors under Small A and Small B categories without similar experience on the contract to be bid may be allowed to bid if the cost of such contract is not more than the Allowable Range of Contract Cost (ARCC) of their registration based on the guidelines as prescribed by the PCAB.		
	Must be supported with the following:		
	A. Contract / Purchase Order		
	B. Certificate of Completion / Acceptance or Inspection Report or Official Receipt		
	C. Validate Contractors/Constructors Performance Evaluation System (CPES) in DPWH website.		

PROCUREMENT MANAGEMENT OFFICE BIDS AND AWARDS COMMITTEE

Mobile Nos. 0905-229-0526/0908-332-2024 (Goods), 0948-768-5848 (Infra)
Telefax: (082) 553-9579

Website: www.davaodelsur.gov.ph/pggo-bac

Email Add: bac.davaodelsur2@gmail.com/sba@davaodelsur@gmail.com

A Davao Davao del Sur

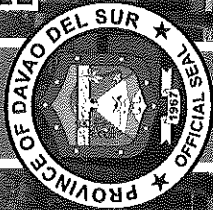

Meangog
RGS
Palabas

9. Omnibus Sworn Statement must be in prescribed form (1 to 9) and duly notarized		
10. Net Financial Contracting Capacity (NFCC) must be reconciled with the Audited Financial Statements		
11. Income Tax Return as of 2020		
12. Business Tax Return Quarterly or Monthly as of 2021		
13. Construction Methods must conform with the approved plan		
14. Construction schedule and S-Curve must conform with the prescribed contract duration and the bid amount		
15. PERT-CPM must conform with the contract duration		
16. Manpower Utilization must conform with the POW		
17. Equipment Utilization must conform with the POW		
18. Duly Notarized Affidavit of Site Inspection		
19. Duly Notarized Compliance to Existing Labor Laws and Standards		

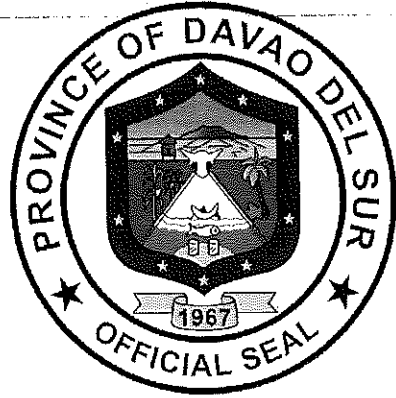

REPUBLIC OF THE PHILIPPINES
PROVINCE OF DAVAO DEL SUR
PROVINCIAL ENGINEER'S OFFICE
SAN AGUSTIN, DIGOS CITY, DAVAO DEL SUR

DETAILED ENGINEERING DESIGN FOR

REPAIR/IMPROVEMENT OF FLOOD CONTROL STRUCT

LOCATION: SINAWILAN, DIGOS CITY, DAVAO DEL SUR

PROJECT LIMITS:

SECTION A ----- Sta. 0+000.00 - Sta. 0+136.00

SECTION B ----- Sta. 0+000.00 - Sta. 0+82.00

SECTION C ----- Sta. 0+000.00 - Sta. 0+24.00

TOTAL PROJECT LENGTH: 242.00m

TABLE OF CONTENTS

COVER PAGE	-----
TABLE OF CONTENTS	-----
LOCATION & VICINITY MAP	-----
GENERAL NOTES	-----
COA PROJECT BILLBOARDS & SUMMARY OF QUANTITIES	-----
GENERAL PLAN	-----
PLAN AND PROFILE	-----
TYPICAL DETAIL OF CONCRETE RIVETMENT	-----
CROSS SECTION	-----



VICINITY MAP



GENERAL NOTES:

1. ALIGNMENT AND GRADE ARE SUBJECT TO ADJUSTMENT TO SUIT EXISTING FIELD CONDITIONS.
2. DISTANCES AND ELEVATION ARE IN METERS UNLESS OTHERWISE INDICATED.
3. FIGURE SHALL GOVERN OVER SCALED DIMENSION IN CASE OF DISCREPANCIES.
4. ALL WORKS SHALL COMPLY WITH THE "DPWH STANDARD SPECIFICATIONS FOR PUBLIC WORKS STRUCTURES (BUILDINGS, PORTS AND HARBORS, FLOOD CONTROL AND DRAINAGE STRUCTURES, AND WATER SUPPLY SYSTEMS), VOLUME III, SERIES 2019."
5. THE AS-STAKED PLAN SHALL BE PREPARED BY THE CONTRACTOR BASED ON THE PRE-CONSTRUCTION SURVEY JOINTLY CONDUCTED BY THE CONTRACTOR AND IMPLEMENTING OFFICE (CONSTRUCTION DIVISION AND PLANNING AND PROGRAMMING DIVISION).
6. FORMWORKS SHALL NOT BE REMOVED WITHOUT THE CONSENT OF THE ENGINEER.
7. **EARTHWORKS**
ALL EXCAVATIONS SHALL BE FINISHED TO REASONABLY SMOOTH AND UNIFORM SURFACES. NO MATERIALS SHALL BE WASTED WITHOUT AUTHORITY OF THE ENGINEER. EXCAVATION OPERATIONS SHALL BE CONDUCTED SO THAT MATERIAL OUTSIDE OF THE LIMIT OF SLOPES WILL NOT BE DISTURBED.

FIELD DENSITY TEST (FDT) FOR EACH COMPACTION PROCESS SHALL BE OBTAINED. COMPACTION PROCESS OF THE SUBJECT LAYER SHALL BE CONTINUED UNTIL THE REQUIRED DEGREE OF COMPACTION HAVE BEEN ATTAINED.

THE GROUND SHALL BE EXCAVATED WHERE NECESSARY IN ACCORDANCE WITH THE DIMENSIONS, LINES AND GRADES AS SHOWN ON THE PLANS.
8. **REINFORCING STEEL**
REINFORCING STEEL SHALL BE DEFORMED BILLET - STEEL BARS CONFORMING TO THE PHILIPPINE NATIONAL STANDARD (PNS 49) GRADE 275, INTERMEDIATE GRADE WITH A MINIMUM YIELD STRENGTH $F_y = 275.8 \text{ MPa}$ (40,000 psi). CONCRETE PROTECTION FOR REINFORCING STEEL BARS SHALL NOT BE LESS THAN (8) CENTIMETERS.
9. **STRUCTURAL CONCRETE**
ALL CONCRETE MIXTURES TO BE USED FOR REINFORCED CONCRETE SHALL BE CLASS "A" AND SHALL HAVE MINIMUM ULTIMATE COMPRESSIVE STRENGTH AT 28 DAYS $F_c' = 20.70 \text{ MPa}$ (3,000 psi).
10. **GROUTED RIPRAP**
BOULDERS 25-30 cm IN DIAMETER SHALL BE USED FOR THE FACING AND SHALL BE HAND-LAID WITH

ENTIRE QUANTITY THEREOF SHALL CONSIST OF PIECES THE LEAST DIMENSION SHALL BE NOT LESS THAN 1 dm³.

QUARRY RUN MAY BE CONSIDERED CLASS III ROCKS.

2. METHOD OF PLACING CLASS "III" ROCKS

THE LARGER PIECES OF FACING ROCK (CLASS III ROCK) SHALL BE PLACED ON THE OUTER SURFACE. ALLOWANCE BEING MADE FOR POSSIBLE SETTLEMENT. THE LARGER PIECES OF ROCK SHALL BE PLACED ON THE OUTER SURFACE. THE LONGEST DIMENSION WILL BE APPROXIMATELY NORMAL TO THE PLANE OF THE ROCKS SHOWN ON THE PLANS. THE PLANE OF THE ROCKS SHALL BE PRESCRIBED LINES AND GRADES INDICATED ON THE PLANS, AS APPROVED BY THE ENGINEER. NO CUTTING, SPOILING OR COURSING OF THE ROCK SHALL BE PERMITTED. ROCKS SHALL BE FIRMLY BEDDED INTO THE SLOPES AND AGAINST THE ADJACENT ROCKS IN A SKILLFUL MANNER WHICH IMPLIES CAREFUL SELECTION AND PLACEMENT SO THAT THE FINISHED SURFACE SHALL BE EVEN AND TIGHT. FILLER ROCKS SHALL BE WEDGED FIRMLY IN BETWEEN THE FACING ROCKS AND BE IN A STABLE POSITION. FILLER ROCKS SHALL BE OF THE KIND AND SIZE AS APPROVED BY THE ENGINEER. FILLER ROCKS SHALL NOT BE OUT ON THE FACES OF THE BULKHEAD BUILT OUTWARD.

3. CONCRETE GROUT SHALL BE USED TO FILL CREVICES OF THE ROCKS WITH A THICKNESS OF 150 MM AS SHOWN ON THE PLANS. THE SURFACE SHALL BE AFTER GROUTING, THE SURFACE SHALL BE CURED. THE EDGES SHOULD BE FACING DOWNWARDS TO AVOID PROTRUSION.

12. DESIGN WAS BASED ON SURVEY DATA SUBMITTED BY THE PLANNING AND PROGRAMMING DIVISION OF PEO DAVAO DEL NORTE.

DIGITAL PRINTED TARPULIN PLACED ON 2-SHEETS
 1.1mm x 1.2m x 2.4m PLYWOOD WITH WOODEN FRAME
 (COA PROJECT BILLBOARD STANDARD)

2.40



Republic of the Philippines
 PROVINCE OF DAVAO DEL SUR
 Mati, Digos City

OFFICE OF THE PROVINCIAL ENGINEER
 San Agustin, Digos City



Project: _____ Cost: _____
 Location: _____ Fund Source/s: _____

Implementing Agency/ies: _____
 Development Partner/s: _____
 Contractor/Supplier: _____
 Brief Description of Project: _____

Project Details:

Duration	Project Date		Project Status				Remarks
	Started	Target Date of Completion	Percentage of Completion	As of (Date)	Cost Incurred to Date	Date Completed	

For particulars or complaints about this project, please contact the Regional Office or Cluster which has audit jurisdiction on this project:

COA Regional Office No./Cluster: _____
 Address: _____
 Contact No.: _____ or Text COA Citizen's Desk at 0915-5391957

2.40

0.60

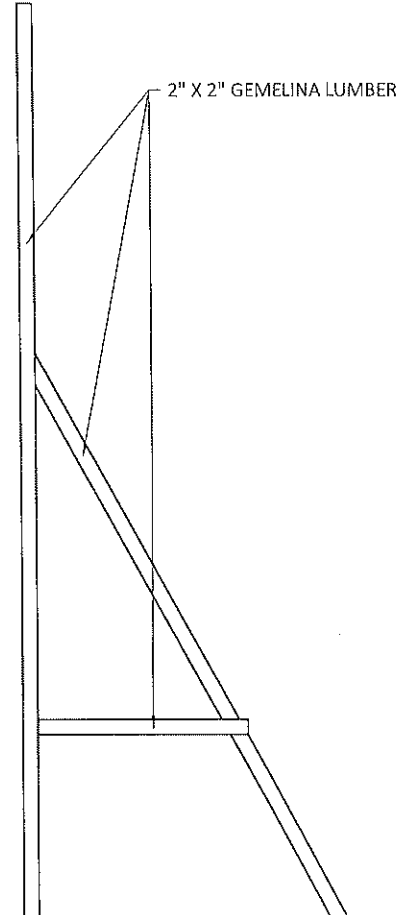

SUMMARY OF QUANTITIES

ITEM NO.	DESCRIPTION
PART B OTHER GENERAL REQUIREMENTS	
B.5	Project Billboard/Signboard
B.7	Occupational Safety and Health
B.9	Mobilization/Demobilization
B.17	Temporary Diversion of waterway
PART J BULKHEADS	
1501(6)	Rockworks, Class III Rock
PART L FLOOD CONTROL AND DRAINAGE (Earthwork Slope Protection Works)	
101(1)	Removal of Structures and Obstructions
1700(1)	Clearing & Grubbing
1700(3)	Individual Removal Of Trees
1702(1)a	Structure Excavation (Common Soil)
1705(1)	Fill and Backfill
1710(2)a	Grouted Riprap, Class A
1712(1)	Concrete Slope Protection

PROJECT BILLBOARD (COA STANDARDS)
 SCALE 1:25m

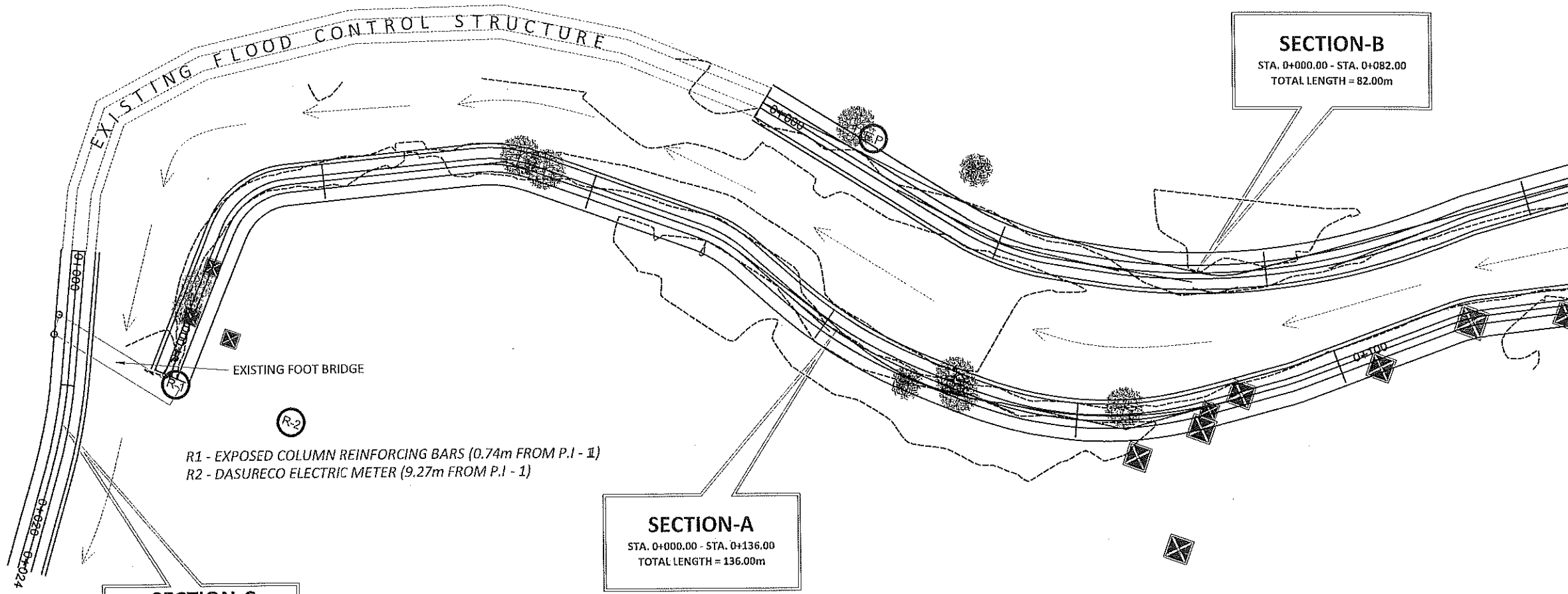
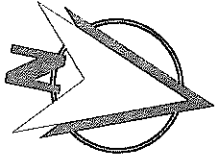

EXISTING FLOOD CONTROL STRUCTURE

EXISTING FOOT BRIDGE

R1 - EXPOSED COLUMN REINFORCING BARS (0.74m FROM P.I - 1)
R2 - DASURECO ELECTRIC METER (9.27m FROM P.I - 1)

SECTION-B
STA. 0+000.00 - STA. 0+082.00
TOTAL LENGTH = 82.00m

SECTION-A
STA. 0+000.00 - STA. 0+136.00
TOTAL LENGTH = 136.00m

SECTION-C
(REMOVAL & REPLACEMENT)

0+000
0+020
0+024

0+050

0+100

0+130

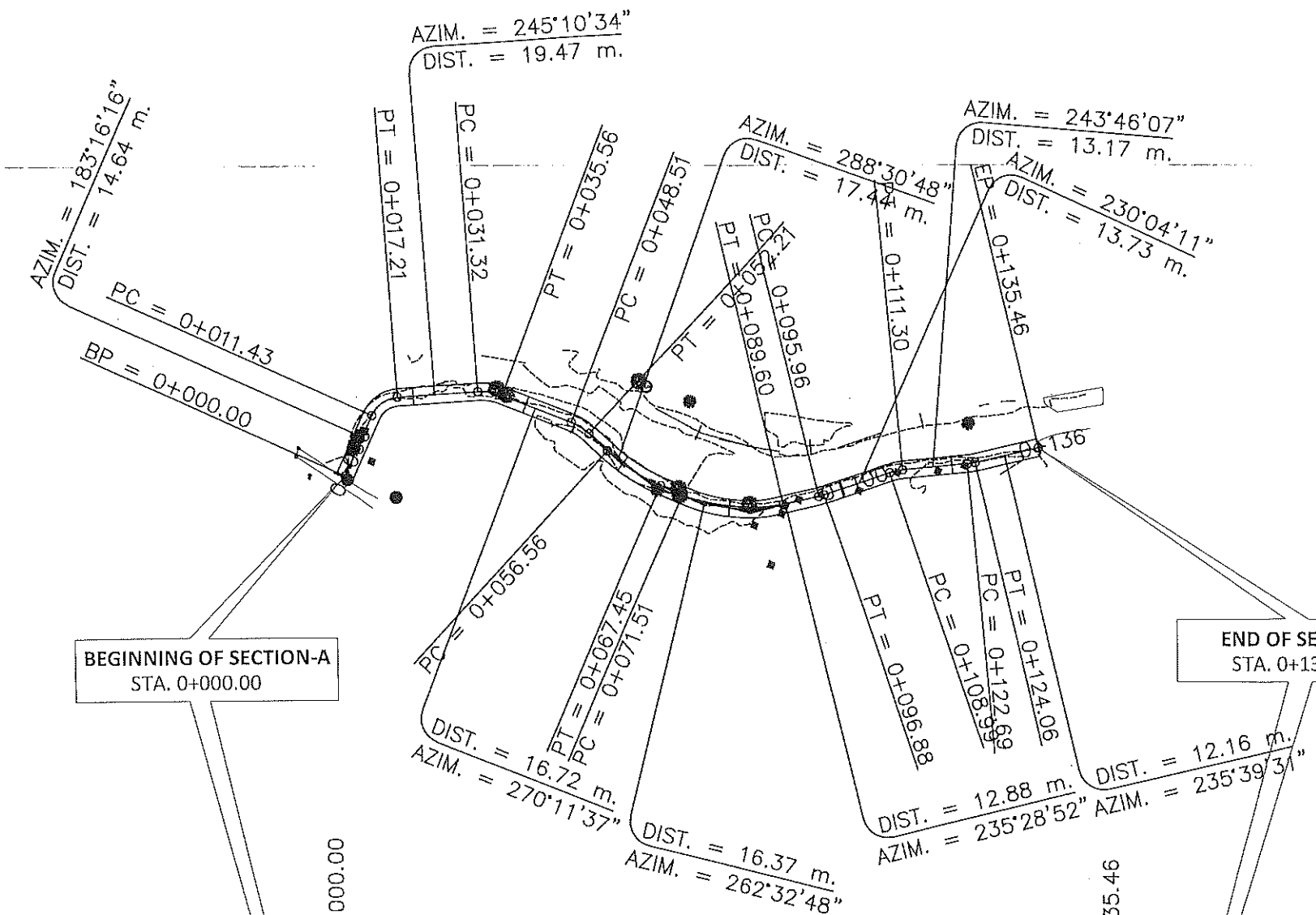

BEGINNING OF SECTION-A
STA. 0+000.00

END OF SECTION-A
STA. 0+136.00

GRADE BREAK STA = 0+000.00
PVI ELEV = 10.50

GRADE BREAK STA = 0+135.46
PVI ELEV = 10.50

AZIM. = 183°16'16"
DIST. = 14.64 m.

AZIM. = 245°10'34"
DIST. = 19.47 m.

AZIM. = 288°30'48"
DIST. = 17.44 m.

AZIM. = 243°46'07"
DIST. = 13.17 m.

AZIM. = 230°04'11"
DIST. = 13.73 m.

AZIM. = 270°11'37"
DIST. = 16.72 m.

AZIM. = 262°32'48"
DIST. = 16.37 m.

AZIM. = 235°28'52"
DIST. = 12.88 m.

AZIM. = 235°39'31"
DIST. = 12.16 m.

BP = 0+000.00
PC = 0+011.43

PT = 0+017.21

PC = 0+031.32

PT = 0+035.56

PC = 0+048.51

PT = 0+089.60

PC = 0+095.96

PT = 0+111.30

PC = 0+135.46

PC = 0+056.56

PT = 0+067.45

PC = 0+071.51

PT = 0+096.88

PC = 0+108.99

PT = 0+124.06

BEGINNING OF SECTION-B
STA. 0+000.00

END OF SECTION-B
STA. 0+82.00

TO GRADE BREAK STA = 0+000.00
PVI ELEV = 10.50

DIST. = 20.37 m.
AZIM. = 277°41'52"

PT = 0+023.82
PC = 0+026.84

BP = 0+000.00
PC = 0+017.72

AZIM. = 263°37'02"
DIST. = 16.06
PC = 0+070.42

DIST. = 36.32 m.
AZIM. = 235°30'00"

AZIM. = 244°12'24"
DIST. = 9.37 m.

ELEV. = 0+081.96
ELEV. = 0+076.59

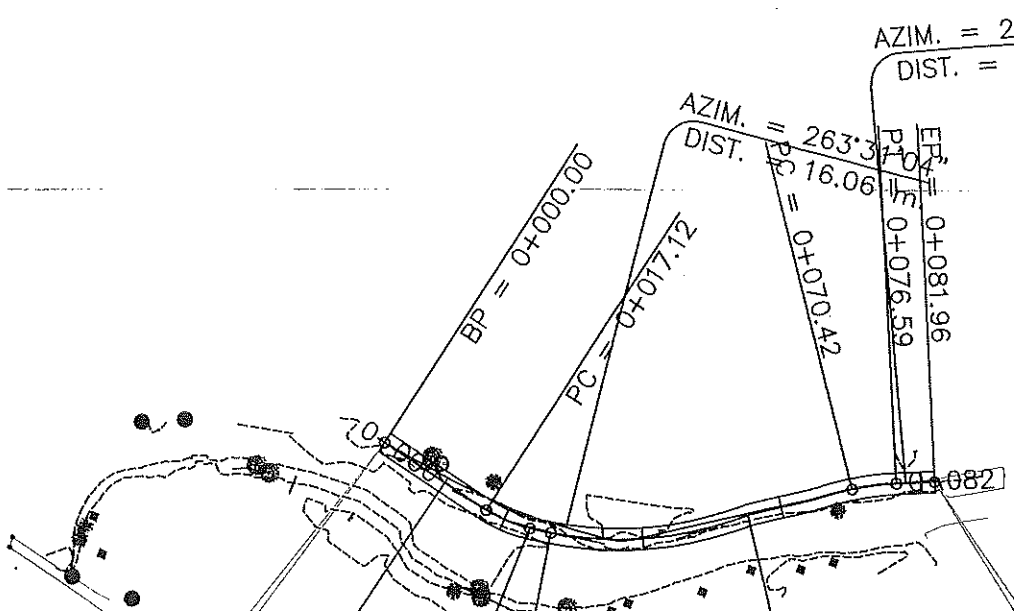

BEGINNING OF SECTION-C
STA. 0+000.00

BREAK STA = 0+000.00

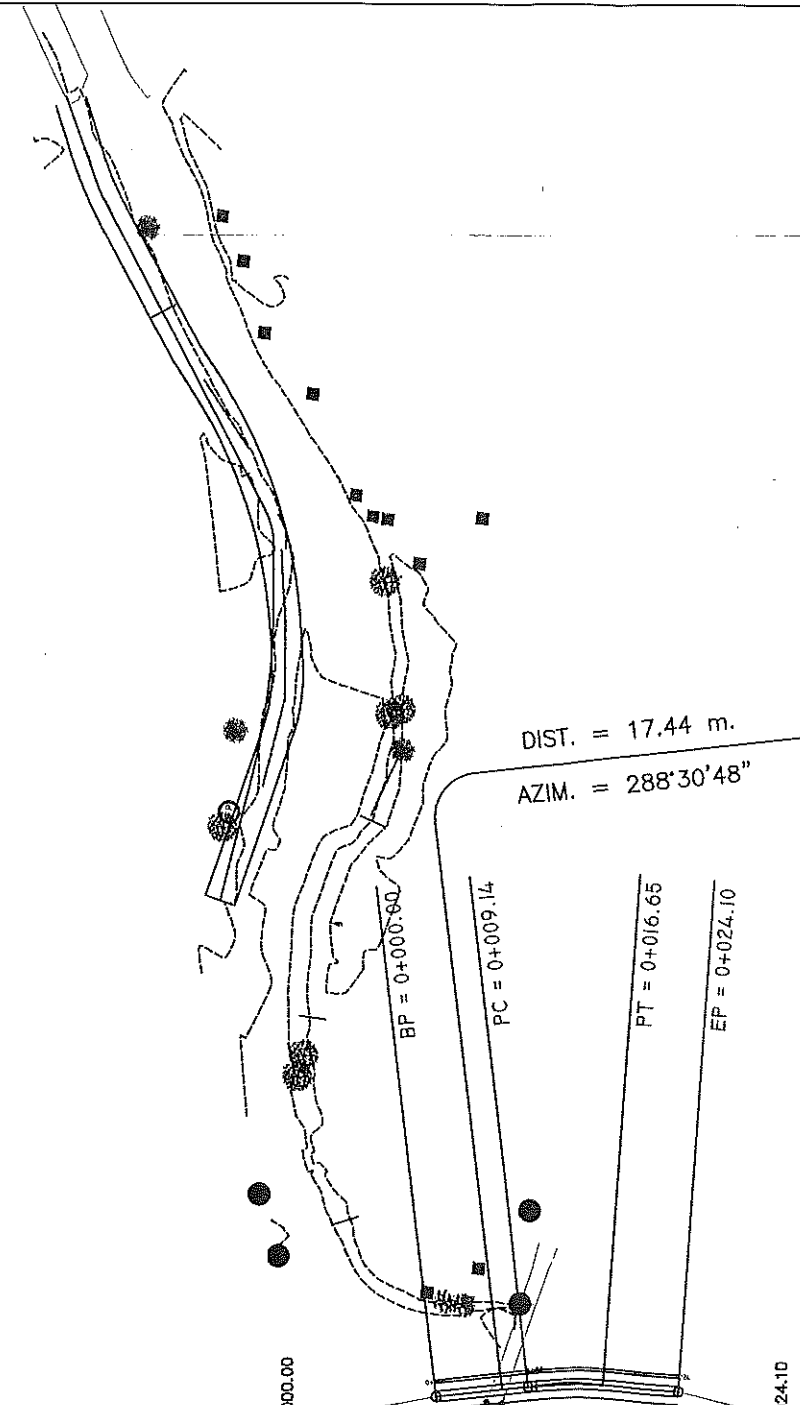

BREAK STA = 0+024.10

END OF SECTION-C
STA. 0+24.00



TYPICAL DETAIL OF CONCRETE REVETMENT

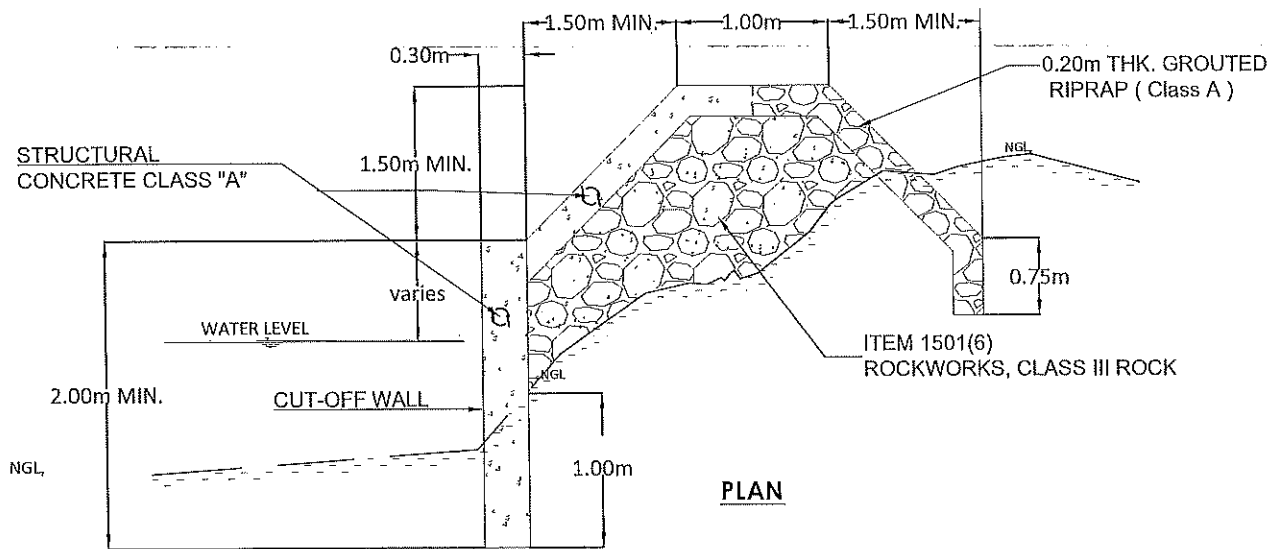

(BAR 4) 18 -16mmØ DEF. BARS, HORIZONTAL REINF. WITH (BAR 1)-12mmØ TIE BARS SP @ 0.25m

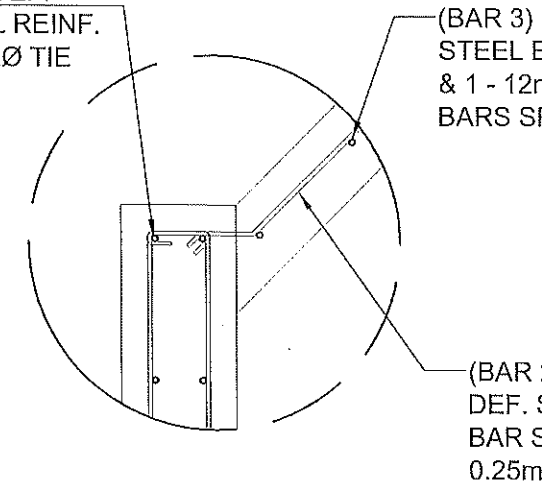

Detail "A"

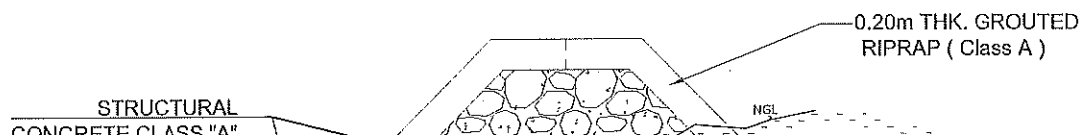
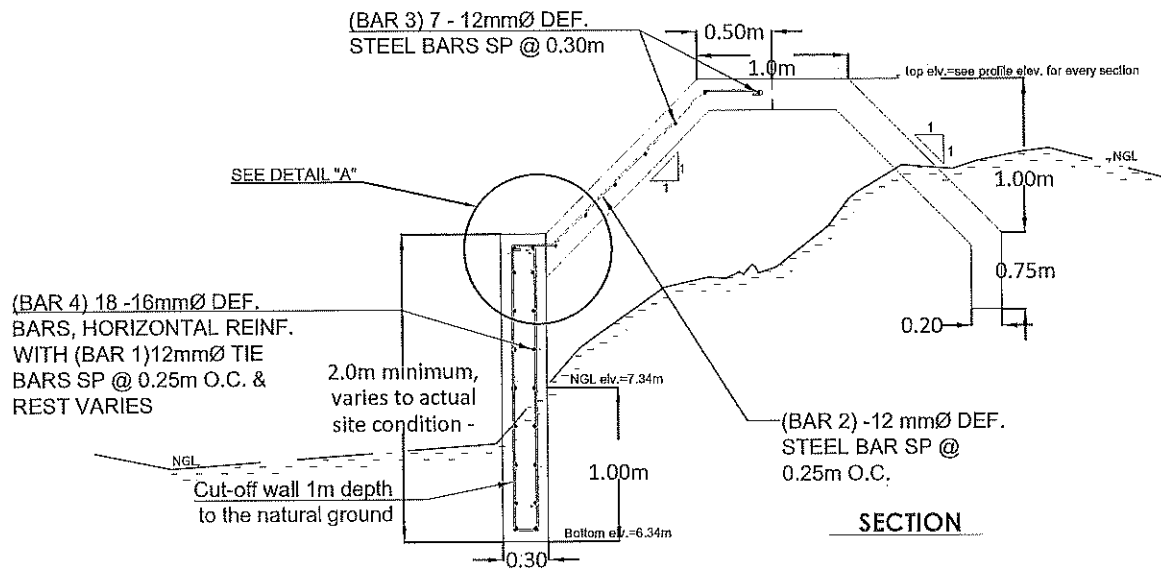

SCHEDULE OF REBARS

BAR NO.	SHAPE	LOCATION	BAR SIZE (mm)
①		CUT-OFF WALL	12mm
②		SLAB & INCLINED WALL	12mm

